

2019 VAN STORAGE EQUIPMENT



RAM VAN SOLUTIONS

FOR PROMASTER® AND PROMASTER CITY™ VANS



RAM



WWW.WEATHERGUARD.COM

weather guard DESIGNED WITH THE PROFESSIONAL IN MIND

WEATHER GUARD® Van Solutions deliver unmatched organization, productivity, and durability, backed by a Limited Lifetime Warranty.



WEATHER GUARD® Van Solutions are ready to roll with game changing improvements based on years of research and your input. Completely retooled shelving, improved bulkheads, customizable organizational features, and a host of smart new accessories, designed around the common sense idea that tools and equipment belong on the shelf, not the floor.



The fast lane for small business.

Check out RAM's Business Link program and receive upfit assistance cash from RAM on Weather Guard Interiors and Roof Racks for your new RAM van! Eligible commercial customers will receive up to \$1,000 on upfits valued at \$1,000 or more with the purchase or lease of any new Promaster cargo van; and up to \$500 on upfits valued at \$500 or more, with the purchase or lease of any new Promaster City cargo van. A local Weather Guard upfitter will complete the installation for you.

Incentives may change without notice. See your local RAM dealer for full program details. Incentive details are different in Canada.

TABLE OF CONTENTS

- BASE PACKAGES.....4-13**
 - Mid-Roof, 118" WB..... 4-5
 - Mid/High-Roof, 136" WB 6-7
 - High-Roof, 159" WB 8-9
 - High-Roof, 159" WB, Extended Length..... 10-11
 - ProMaster City 12-13
- BULKHEADS14**
- ADJUSTABLE SHELVING15**
- SECURE STORAGE16**
- ACCESSORIES17**
- CABINETS18**
- DRAWER UNITS.....25**
- ROOF RACKS.....26-27**

The PRO PACKAGES for RAM ProMaster and ProMaster City vans on the next few pages can be used as a complete upfit package or a starting point for a custom upfit. Van layout dimensions are on the back cover if you're looking for something more custom or just need some detailed information about your van's interior. If you need more help, your local WEATHER GUARD® Truck and Van Equipment distributor is a great resource for all your upfitting questions.

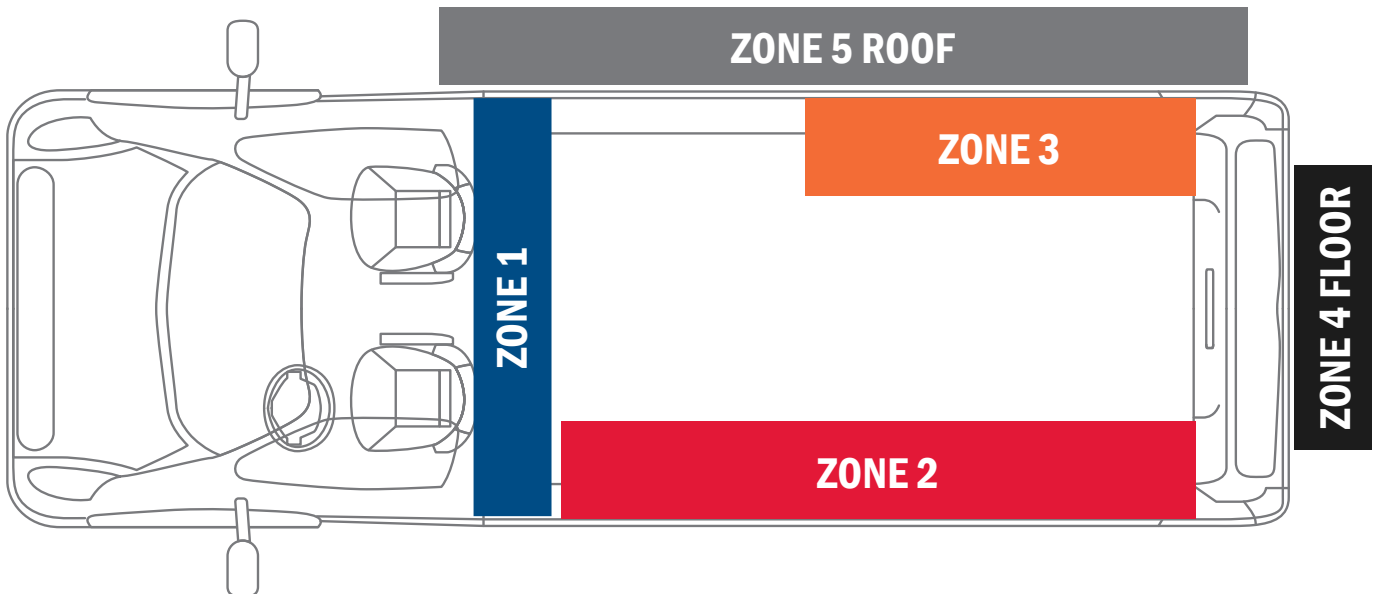

LOW ROOF PACKAGES 118" WHEEL BASE



From contractors to plumbers and electricians, we know that hard working professionals need flexibility to fit a new van to the job. These packages are customizable for your needs now or in the future with shelving and accessories starting on page 15.

NEW!

ProMaster Low Roof Mounting Kit

- Heavy gauge steel mounting plates distribute shelf load and provide secure mounting to van interior
- Mounts directly to reinforced weld nuts and cargo tie-downs or into existing holes (no drilling)
- Faster installation with reduced risk of damage to van during installation

| MODEL | DESCRIPTION | WEIGHT |
|-------------|---------------------------------------|---------|
| 975201-3-01 | RAM Promaster 118" WB LR Mounting Kit | 18 lbs. |

COMMERCIAL / BASE

DRIVER SIDE

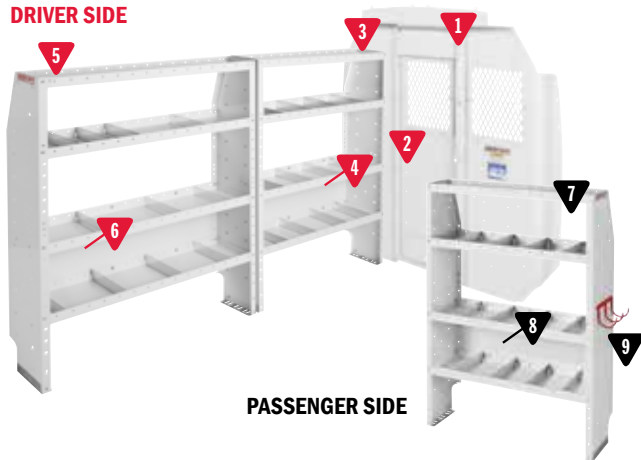

PASSENGER SIDE

600-8440S Commercial Shelving Package

| MODEL | DESCRIPTION | QUANTITY |
|-------|---|----------|
| 1 | 96142-3-01 Screen Bulkhead - ProMaster® | 1 |
| 2 | 96901-3-01 Swing Door Conversion Kit | 1 |
| 3 | 9373-3-03 Adjustable 4 Shelf Unit (36" x 13½" x 60") | 1 |
| 4 | 9603-3-01 Accessory Back Panel (for 36" Shelf Unit 14½" tall) | 1 |
| 5 | 9374-3-03 Adjustable 4 Shelf Unit (42" x 60" x 13½") | 1 |
| 6 | 9604-3-01 Accessory Back Panel (for 42" Shelf Unit 14½" tall) | 1 |
| 7 | 9374-3-03 Adjustable 4 Shelf Unit (42" x 60" x 13½") | 1 |
| 8 | 9604-3-01 Accessory Back Panel (for 42" Shelf Unit 14½" tall) | 1 |
| 9 | 9893-7-01 REDZONE 3 Hook Cord or Tool Holder | 1 |
| *10 | 975201-3-01 Van Shelf Mounting Kit - Promaster 118" WB | 1 |

* Not Shown

GENERAL SERVICE / CONTRACTOR

DRIVER SIDE

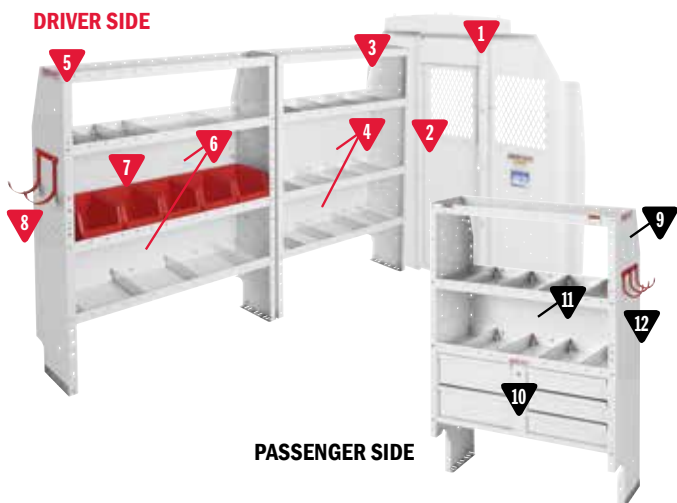

PASSENGER SIDE

600-8441S General Service/Contractor Package

| MODEL | DESCRIPTION | QUANTITY |
|-------|--|----------|
| 1 | 96142-3-01 Screen Bulkhead - ProMaster® | 1 |
| 2 | 96901-3-01 Swing Door Conversion Kit | 1 |
| 3 | 9373-3-03 Adjustable 4 Shelf Unit (36" x 60" x 13½") | 1 |
| 4 | 9603-3-01 Accessory Back Panel (for 36" Shelf Unit 14½" tall) | 2 |
| 5 | 9374-3-03 Adjustable 4 Shelf Unit (42" x 60" x 13½") | 1 |
| 6 | 9604-3-01 Accessory Back Panel (for 42" Shelf Unit 14½" tall) | 2 |
| 7 | 9859-7-01 REDZONE Medium 6 Bin Set (13") | 1 |
| 8 | 9892-7-01 REDZONE 2 Hook Holder (5" diameter) | 1 |
| 9 | 9391-3-03 Heavy Duty Shelf Unit (for Secure Storage Modules - 42" x 60" x 16") | 1 |
| 10 | 9045-3-02 5 Drawer Secure Storage Module (42" x 17" x 16") | 1 |
| 11 | 9604-3-01 Accessory Back Panel (for 42" Shelf Unit 14½" tall) | 1 |
| 12 | 9893-7-01 REDZONE 3 Hook Cord or Tool Holder | 1 |
| *13 | 975201-3-01 Van Shelf Mounting Kit - Promaster 118" WB | 1 |

* Not Shown

CABLE / PLUMBING

DRIVER SIDE



PASSENGER SIDE

600-8442S Cable/Plumber Package

| MODEL | DESCRIPTION | QUANTITY |
|-------|--|----------|
| 1 | 96142-3-01 Screen Bulkhead - ProMaster® | 1 |
| 2 | 96901-3-01 Swing Door Conversion Kit | 1 |
| 3 | 9373-3-03 Adjustable 4 Shelf Unit (36" x 60" x 13½") | 1 |
| 4 | 9603-3-01 Accessory Back Panel (for 36" Shelf Unit 14½" tall) | 2 |
| 5 | 9374-3-03 Adjustable 4 Shelf Unit (42" x 60" x 13½") | 1 |
| 6 | 9604-3-01 Accessory Back Panel (for 42" Shelf Unit 14½" tall) | 2 |
| 7 | 9893-7-01 REDZONE 3 Hook Cord or Tool Holder | 1 |
| 8 | 9391-3-03 Heavy Duty Shelf Unit (for Secure Storage Modules - 42" x 60" x 16") | 1 |
| 9 | 9045-3-02 5 Drawer Secure Storage Module (42" x 17" x 16") | 1 |
| 10 | 9604-3-01 Accessory Back Panel (for 42" Shelf Unit 14½" tall) | 1 |
| 11 | 9893-7-01 REDZONE 3 Hook Cord or Tool Holder | 1 |
| 12 | 9504-3-01 Shelf Door (for 42" Shelf Unit) | 1 |
| *13 | 975201-3-01 Van Shelf Mounting Kit - Promaster 118" WB | 1 |

* Not Shown

HVAC / MECHANICAL

DRIVER SIDE

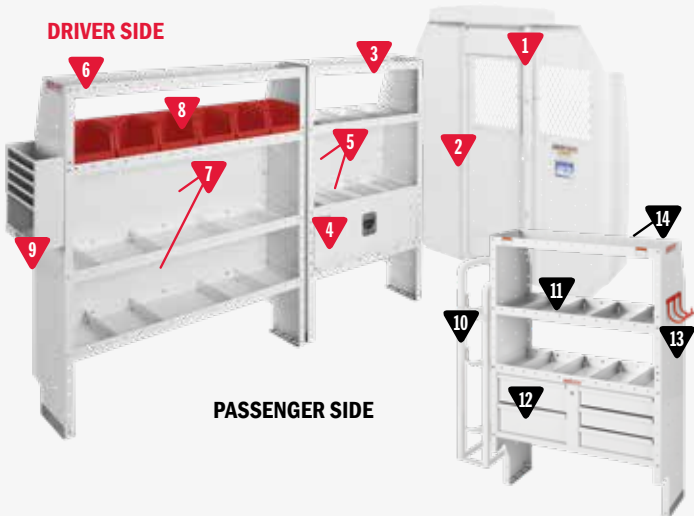

PASSENGER SIDE

600-8443S HVAC/Mechanical Package

| MODEL | DESCRIPTION | QUANTITY |
|-------|--|----------|
| 1 | 96142-3-01 Screen Bulkhead - ProMaster® | 1 |
| 2 | 96901-3-01 Swing Door Conversion Kit | 1 |
| 3 | 9373-3-03 Adjustable 4 Shelf Unit (36" x 60" x 13½") | 1 |
| 4 | 9503-3-01 Shelf Door (for 36" Shelf Unit) | 1 |
| 5 | 9603-3-01 Accessory Back Panel (for 36" Shelf Unit 14½" tall) | 2 |
| 6 | 9374-3-03 Adjustable 4 Shelf Unit (42" x 60" x 13½") | 1 |
| 7 | 9604-3-01 Accessory Back Panel (for 42" Shelf Unit 14½" tall) | 2 |
| 8 | 9859-7-01 REDZONE Medium 6 Bin Set (13") | 1 |
| 9 | 9880-3-01 Literature Holder 6 Compartment | 1 |
| 10 | 9863-3-01 Refrigerant Tank Rack (2x 30#, 1x 50#) | 1 |
| 11 | 9391-3-03 Heavy Duty Shelf Unit (for Secure Storage Modules - 42" x 60" x 16") | 1 |
| 12 | 9045-3-02 5 Drawer Secure Storage Module (42" x 17" x 16") | 1 |
| 13 | 9893-7-01 REDZONE 3 Hook Cord or Tool Holder | 1 |
| *14 | 975201-3-01 Van Shelf Mounting Kit - Promaster 118" WB | 1 |

* Not Shown

ELECTRICAL

DRIVER SIDE

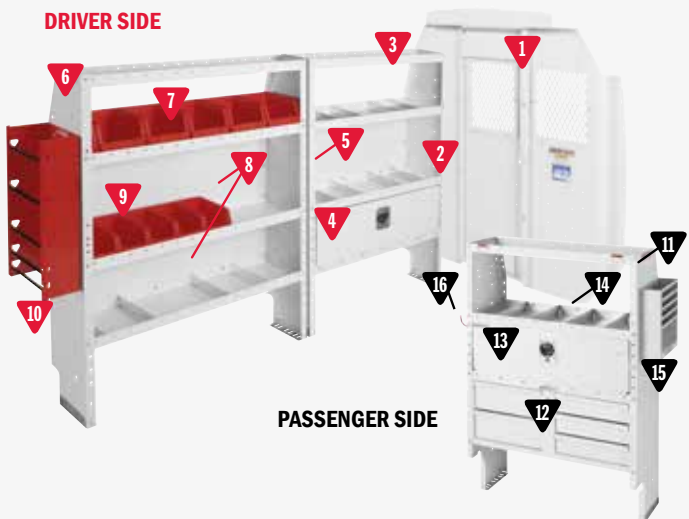

PASSENGER SIDE

600-8444S Electrical Package

| MODEL | DESCRIPTION | QUANTITY |
|-------|--|----------|
| 1 | 96142-3-01 Screen Bulkhead - ProMaster® | 1 |
| 2 | 96901-3-01 Swing Door Conversion Kit | 1 |
| 3 | 9373-3-03 Adjustable 4 Shelf Unit (36" x 60" x 13½") | 1 |
| 4 | 9503-3-01 Shelf Door (for 36" Shelf Unit) | 1 |
| 5 | 9603-3-01 Accessory Back Panel (for 36" Shelf Unit 14½" tall) | 2 |
| 6 | 9374-3-03 Adjustable 4 Shelf Unit (42" x 44" x 13½") | 1 |
| 7 | 9859-7-01 REDZONE Medium 6 Bin Set (13") | 1 |
| 8 | 9604-3-01 Accessory Back Panel (for 42" Shelf Unit 14½" tall) | 2 |
| 9 | 9858-7-01 REDZONE Small 6 Bin Set (13") | 1 |
| 10 | 9882-7-01 REDZONE Wire Spool Holder End Mount | 1 |
| 11 | 9391-3-03 Heavy Duty Shelf Unit (for Secure Storage Modules - 42" x 60" x 16") | 1 |
| 12 | 9045-3-02 5 Drawer Secure Storage Module (42" x 17" x 16") | 1 |
| 13 | 9504-3-01 Shelf Door (for 42" Shelf Unit) | 1 |
| 14 | 9604-3-01 Accessory Back Panel (for 42" Shelf Unit 14½" tall) | 1 |
| 15 | 9880-3-01 Literature Holder 6 Compartment | 1 |
| 16 | 9893-7-01 REDZONE 3 Hook Cord or Tool Holder | 1 |
| *17 | 975201-3-01 Van Shelf Mounting Kit - Promaster 118" WB | 1 |

* Not Shown

LOW / HIGH ROOF PACKAGES 136" WHEEL BASE

Our Pro Packages help you organize your equipment and supplies, large and small. From recipis, drills and hand tools to expensive test equipment, the packages are customizable to meet your specific storage needs with a wide range of accessories starting on page 17.



NEW!

ProMaster Low/High Roof Mounting Kit

- Heavy gauge steel mounting plates distribute shelf load and provide secure mounting to van interior
- Mounts directly to reinforced weld nuts and cargo tie-downs or into existing holes (no drilling)
- Faster installation with reduced risk of damage to van during installation

| MODEL | DESCRIPTION | WEIGHT |
|-------------|---------------------------------------|---------|
| 975202-3-01 | Promaster 136" WB LR, HR Mounting Kit | 17 lbs. |

COMMERCIAL / BASE

DRIVER SIDE



PASSENGER SIDE

600-8440R Commercial Shelving Package

| MODEL | DESCRIPTION | QUANTITY |
|-------|---|----------|
| 1 | 96142-3-01 Screen Bulkhead - ProMaster® | 1 |
| 2 | 96901-3-01 Swing Door Conversion Kit | 1 |
| 3 | 9374-3-03 Adjustable 4 Shelf Unit (42" x 60" x 13½") | 1 |
| 4 | 9604-3-01 Accessory Back Panel (for 42" shelf unit 14½" tall) | 1 |
| 5 | 9375-3-03 Adjustable 4 Shelf Unit (52" x 60" x 13½") | 1 |
| 6 | 9605-3-01 Accessory Back Panel (or 52" shelf unit 14½" tall) | 1 |
| 7 | 9375-3-03 Adjustable 4 Shelf Unit (52" x 60" x 13½") | 1 |
| 8 | 9605-3-01 Accessory Back Panel (for 52" shelf unit 14½" tall) | 1 |
| 9 | 9893-7-01 REDZONE 3 Hook Cord or Tool Holder | 1 |
| *10 | 975202-3-01 Van Shelf Mounting Kit - ProMaster 136" WB | 1 |

* Not Shown

GENERAL SERVICE / CONTRACTOR

DRIVER SIDE

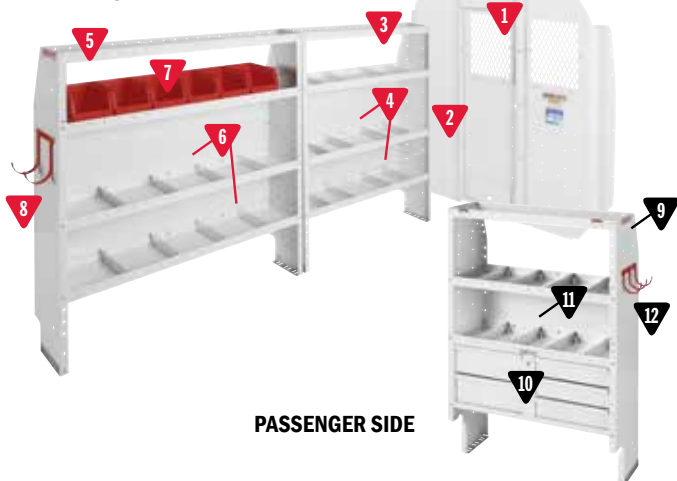

PASSENGER SIDE

600-8441R General Service/Contractor Package

| MODEL | DESCRIPTION | QUANTITY |
|-------|--|----------|
| 1 | 96142-3-01 Screen Bulkhead - ProMaster® | 1 |
| 2 | 96901-3-01 Swing Door Conversion Kit | 1 |
| 3 | 9374-3-03 Adjustable 4 Shelf Unit (42" x 60" x 13½") | 1 |
| 4 | 9604-3-01 Accessory Back Panel (for 42" shelf unit 14½" tall) | 2 |
| 5 | 9375-3-03 Adjustable 4 Shelf Unit (52" x 60" x 13½") | 1 |
| 6 | 9605-3-01 Accessory Back Panel (for 52" shelf unit 14½" tall) | 2 |
| 7 | 9859-7-01 REDZONE Medium 6 Bin Set (13") | 1 |
| 8 | 9892-7-01 REDZONE 2 Hook Holder (5" diameter) | 1 |
| 9 | 9391-3-03 Heavy Duty Shelf Unit (for Secure Storage Modules - 42" x 60" x 16") | 1 |
| 10 | 9045-3-02 5 Drawer Secure Storage Module (42" x 17" x 16") | 1 |
| 11 | 9604-3-01 Accessory Back Panel (for 42" shelf unit 14½" tall) | 1 |
| 12 | 9893-7-01 REDZONE 3 Hook Cord or Tool Holder | 1 |
| *13 | 975202-3-01 Van Shelf Mounting Kit - ProMaster 136" WB | 1 |

* Not Shown

CABLE / PLUMBING

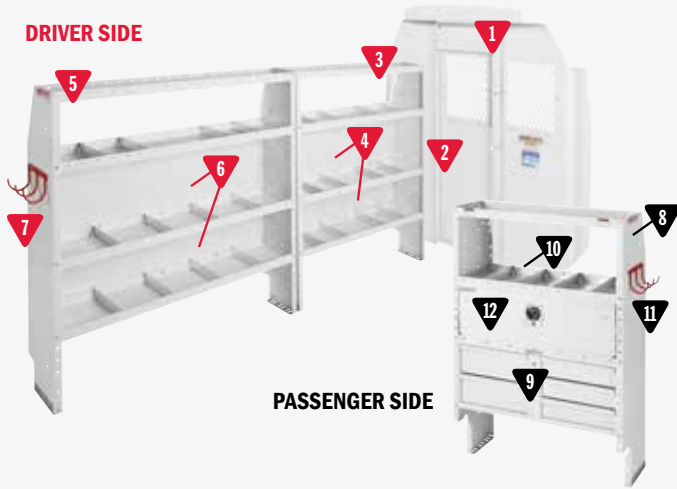

600-8442R Cable/Plumber Package

| MODEL | DESCRIPTION | QUANTITY |
|-------|--|----------|
| 1 | 96142-3-01 Screen Bulkhead - ProMaster® | 1 |
| 2 | 96901-3-01 Swing Door Conversion Kit | 1 |
| 3 | 9374-3-03 Adjustable 4 Shelf Unit (42" x 60" x 13½") | 1 |
| 4 | 9604-3-01 Accessory Back Panel (for 42" Shelf Unit 14½" tall) | 2 |
| 5 | 9375-3-03 Adjustable 4 Shelf Unit (52" x 60" x 13½") | 1 |
| 6 | 9605-3-01 Accessory Back Panel (for 52" Shelf Unit 14½" tall) | 2 |
| 7 | 9893-7-01 REDZONE 3 Hook Cord or Tool Holder | 1 |
| 8 | 9391-3-03 Heavy Duty Shelf Unit (for Secure Storage Modules - 42" x 60" x 16") | 1 |
| 9 | 9045-3-02 5 Drawer Secure Storage Module (42" x 17" x 16") | 1 |
| 10 | 9604-3-01 Accessory Back Panel (for 42" Shelf Unit 14½" tall) | 1 |
| 11 | 9893-7-01 REDZONE 3 Hook Cord or Tool Holder | 1 |
| 12 | 9504-3-01 Shelf Door (for 42" Shelf Unit) | 1 |
| *13 | 975202-3-01 Van Shelf Mounting Kit - ProMaster 136" WB | 1 |

* Not Shown

HVAC / MECHANICAL



600-8443R HVAC/Mechanical Package

| MODEL | DESCRIPTION | QUANTITY |
|-------|--|----------|
| 1 | 96142-3-01 Screen Bulkhead - ProMaster® | 1 |
| 2 | 96901-3-01 Swing Door Conversion Kit | 1 |
| 3 | 9374-3-03 Adjustable 4 Shelf Unit (42" x 60" x 13½") | 1 |
| 4 | 9504-3-01 Shelf Door (for 42" Shelf Unit) | 1 |
| 5 | 9604-3-01 Accessory Back Panel (for 42" Shelf Unit 14½" tall) | 2 |
| 6 | 9375-3-03 Adjustable 4 Shelf Unit (52" x 60" x 13½") | 1 |
| 7 | 9605-3-01 Accessory Back Panel (for 52" Shelf Unit 14½" tall) | 2 |
| 8 | 9859-7-01 REDZONE Medium 6 Bin Set (13") | 1 |
| 9 | 9880-3-01 Literature Holder 6 Compartment | 1 |
| 10 | 9863-3-01 Refrigerant Tank Rack (2x 30#, 1x 50#) | 1 |
| 11 | 9391-3-03 Heavy Duty Shelf Unit (for Secure Storage Modules - 42" x 60" x 16") | 1 |
| 12 | 9045-3-02 5 Drawer Secure Storage Module (42" x 17" x 16") | 1 |
| 13 | 9893-7-01 REDZONE 3 Hook Cord or Tool Holder | 1 |
| *14 | 975202-3-01 Van Shelf Mounting Kit - ProMaster 136" WB | 1 |

* Not Shown

ELECTRICAL



600-8444R Electrical Package

| MODEL | DESCRIPTION | QUANTITY |
|-------|--|----------|
| 1 | 96142-3-01 Screen Bulkhead - ProMaster® | 1 |
| 2 | 96901-3-01 Swing Door Conversion Kit | 1 |
| 3 | 9374-3-03 Adjustable 4 Shelf Unit (42" x 60" x 13½") | 1 |
| 4 | 9504-3-01 Shelf Door (for 42" Shelf Unit) | 1 |
| 5 | 9604-3-01 Accessory Back Panel (for 42" Shelf Unit 14½" tall) | 2 |
| 6 | 9859-7-01 REDZONE Medium 6 Bin Set (13") | 1 |
| 7 | 9375-3-03 Adjustable 4 Shelf Unit (52" x 60" x 13 ½") | 1 |
| 8 | 9605-3-01 Accessory Back Panel (for 52" Shelf Unit 14½" tall) | 2 |
| 9 | 9858-7-01 REDZONE Small 6 Bin Set (13") | 1 |
| 10 | 9882-7-01 REDZONE Wire Spool Holder End Mount | 1 |
| 11 | 9391-3-03 Heavy Duty Shelf Unit (for Secure Storage Modules - 42" x 60" x 16") | 1 |
| 12 | 9045-3-02 5 Drawer Secure Storage Module (42" x 17" x 16") | 1 |
| 13 | 9504-3-01 Shelf Door (for 42" Shelf Unit) | 1 |
| 14 | 9604-3-01 Accessory Back Panel (for 42" Shelf Unit 14½" tall) | 2 |
| 15 | 9880-3-01 Literature Holder 6 Compartment | 1 |
| 16 | 9893-7-01 REDZONE 3 Hook Cord or Tool Holder | 1 |
| *17 | 975202-3-01 Van Shelf Mounting Kit - ProMaster 136" WB | 1 |

* Not Shown

HIGH ROOF PACKAGES 159" WB

From contractors to plumbers and electricians, we know that hard working professionals need flexibility to fit a new van to the job. These packages are customizable for your needs now or in the future with shelving and accessories starting on page 15.



NEW!

ProMaster High Roof Mounting Kit

- Heavy gauge steel mounting plates distribute shelf load and provide secure mounting to van interior
- Mounts directly to reinforced weld nuts and cargo tie-downs or into existing holes (no drilling)
- Faster installation with reduced risk of damage to van during installation

| MODEL | DESCRIPTION | WEIGHT |
|-------------|-----------------------------------|---------|
| 975203-3-01 | Promaster 159" WB HR Mounting Kit | 19 lbs. |

COMMERCIAL / BASE

DRIVER SIDE

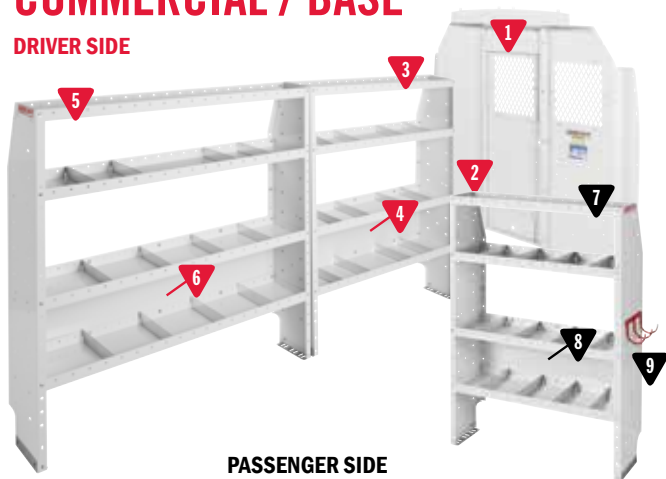

PASSENGER SIDE

600-8440L Commercial Shelving Package

| MODEL | DESCRIPTION | QUANTITY |
|-------|---|----------|
| 1 | 96142-3-01 Screen Bulkhead - ProMaster® | 1 |
| 2 | 96901-3-01 Swing Door Conversion Kit | 1 |
| 3 | 9375-3-03 Adjustable 4 Shelf Unit (52" x 60" x 13½") | 1 |
| 4 | 9605-3-01 Accessory Back Panel (for 52" Shelf Unit 14½" tall) | 1 |
| 5 | 9376-3-03 Adjustable 4 Shelf Unit (60" x 60" x 13½") | 1 |
| 6 | 9606-3-01 Accessory Back Panel (for 60" Shelf Unit 14½" tall) | 1 |
| 7 | 9375-3-03 Adjustable 4 Shelf Unit (52" x 60" x 13½") | 1 |
| 8 | 9605-3-01 Accessory Back Panel (for 52" Shelf Unit 14½" tall) | 1 |
| 9 | 9893-7-01 REDZONE 3 Hook Cord or Tool Holder | 1 |
| *10 | 975203-3-01 Van Shelf Mounting Kit - ProMaster 159" WB | 1 |

* Not Shown

GENERAL SERVICE / CONTRACTOR

DRIVER SIDE

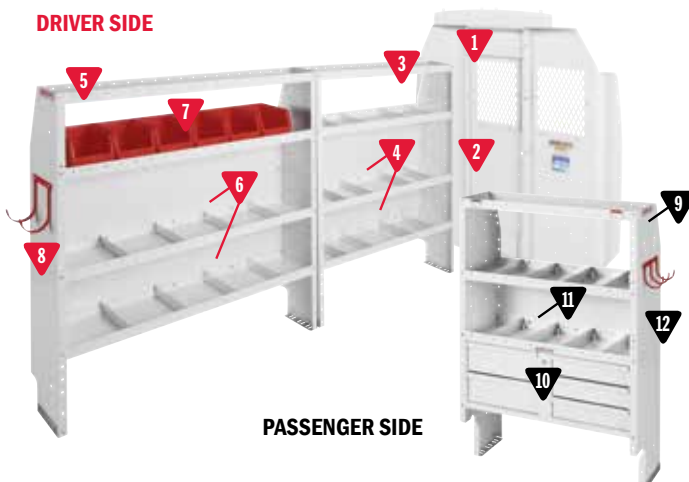

PASSENGER SIDE

600-8441L General Service/Contractor Package

| MODEL | DESCRIPTION | QUANTITY |
|-------|--|----------|
| 1 | 96142-3-01 Screen Bulkhead - ProMaster® | 1 |
| 2 | 96901-3-01 Swing Door Conversion Kit | 1 |
| 3 | 9375-3-03 Adjustable 4 Shelf Unit (52" x 60" x 13½") | 1 |
| 4 | 9605-3-01 Accessory Back Panel (for 52" Shelf Unit 14½" tall) | 2 |
| 5 | 9376-3-03 Adjustable 4 Shelf Unit (60" x 60" x 13½") | 1 |
| 6 | 9606-3-01 Accessory Back Panel (for 60" Shelf Unit 14½" tall) | 2 |
| 7 | 9859-7-01 REDZONE Medium 6 Bin Set (13") | 1 |
| 8 | 9892-7-01 REDZONE 2 Hook Holder (5" diameter) | 1 |
| 9 | 9391-3-03 Heavy Duty Shelf Unit (for Secure Storage Modules - 42" x 60" x 16") | 1 |
| 10 | 9045-3-02 5 Drawer Secure Storage Module (42" x 17" x 16") | 1 |
| 11 | 9604-3-01 Accessory Back Panel (for 42" Shelf Unit 14½" tall) | 1 |
| 12 | 9893-7-01 REDZONE 3 Hook Cord or Tool Holder | 1 |
| *13 | 975203-3-01 Van Shelf Mounting Kit - ProMaster 159" WB | 1 |

* Not Shown

CABLE / PLUMBING

DRIVER SIDE

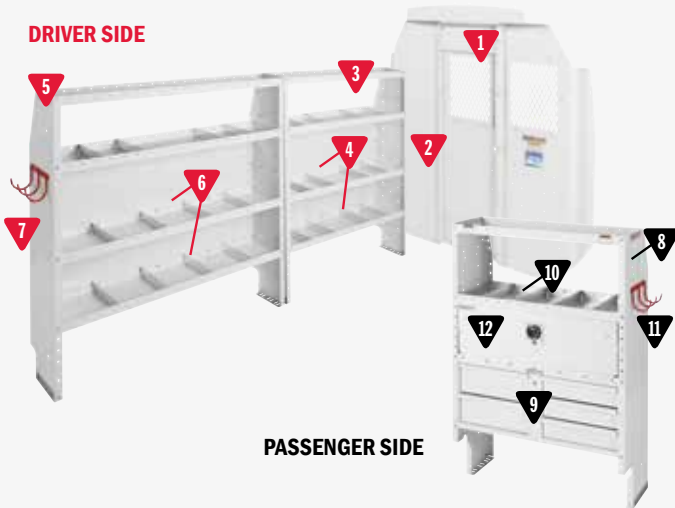

PASSENGER SIDE

600-8442L Cable/Plumber Package

| MODEL | DESCRIPTION | QUANTITY |
|-------|--|----------|
| 1 | 96142-3-01 Screen Bulkhead - ProMaster® | 1 |
| 2 | 96901-3-01 Swing Door Conversion Kit | 1 |
| 3 | 9375-3-03 Adjustable 4 Shelf Unit (52" x 60" x 13½") | 1 |
| 4 | 9605-3-01 Accessory Back Panel (for 52" Shelf Unit 14½" tall) | 2 |
| 5 | 9376-3-03 Adjustable 4 Shelf Unit (60" x 60" x 13½") | 1 |
| 6 | 9606-3-01 Accessory Back Panel (for 60" Shelf Unit 14½" tall) | 2 |
| 7 | 9893-7-01 REDZONE 3 Hook Cord or Tool Holder | 1 |
| 8 | 9391-3-03 Heavy Duty Shelf Unit (for Secure Storage Modules - 42" x 60" x 16") | 1 |
| 9 | 9045-3-02 5 Drawer Secure Storage Module (42" x 17" x 16") | 1 |
| 10 | 9604-3-01 Accessory Back Panel (for 42" Shelf Unit 14½" tall) | 1 |
| 11 | 9893-7-01 REDZONE 3 Hook Cord or Tool Holder | 1 |
| 12 | 9504-3-01 Shelf Door (for 42" Shelf Unit) | 1 |
| *13 | 975203-3-01 Van Shelf Mounting Kit - ProMaster 159" WB | 1 |

* Not Shown

HVAC / MECHANICAL

DRIVER SIDE

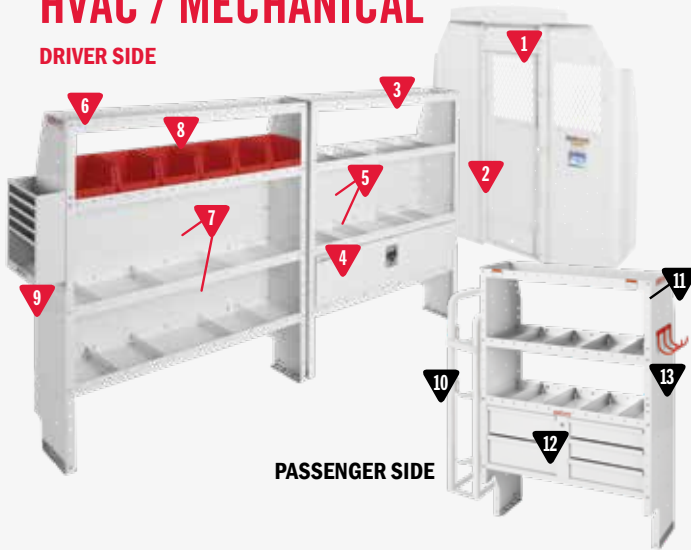

PASSENGER SIDE

600-8443L HVAC/Mechanical Package

| MODEL | DESCRIPTION | QUANTITY |
|-------|--|----------|
| 1 | 96142-3-01 Screen Bulkhead - ProMaster® | 1 |
| 2 | 96901-3-01 Swing Door Conversion Kit | 1 |
| 3 | 9375-3-03 Adjustable 4 Shelf Unit (52" x 60" x 13½") | 1 |
| 4 | 9505-3-01 Shelf Door (for 52" Shelf Unit) | 1 |
| 5 | 9605-3-01 Accessory Back Panel (for 52" Shelf Unit 14½" tall) | 2 |
| 6 | 9376-3-03 Adjustable 4 Shelf Unit (60" x 60" x 13½") | 1 |
| 7 | 9606-3-01 Accessory Back Panel (for 60" Shelf Unit 14½" tall) | 2 |
| 8 | 9859-7-01 REDZONE Medium 6 Bin Set (13") | 1 |
| 9 | 9880-3-01 Literature Holder 6 Compartment | 1 |
| 10 | 9863-3-01 Refrigerant Tank Rack (2x 30#, 1x 50#) | 1 |
| 11 | 9391-3-03 Heavy Duty Shelf Unit (for Secure Storage Modules - 42" x 60" x 16") | 1 |
| 12 | 9045-3-02 5 Drawer Secure Storage Module (42" x 17" x 16") | 1 |
| 13 | 9893-7-01 REDZONE 3 Hook Cord or Tool Holder | 1 |
| *14 | 975203-3-01 Van Shelf Mounting Kit - ProMaster 159" WB | 1 |

* Not Shown

ELECTRICAL

DRIVER SIDE

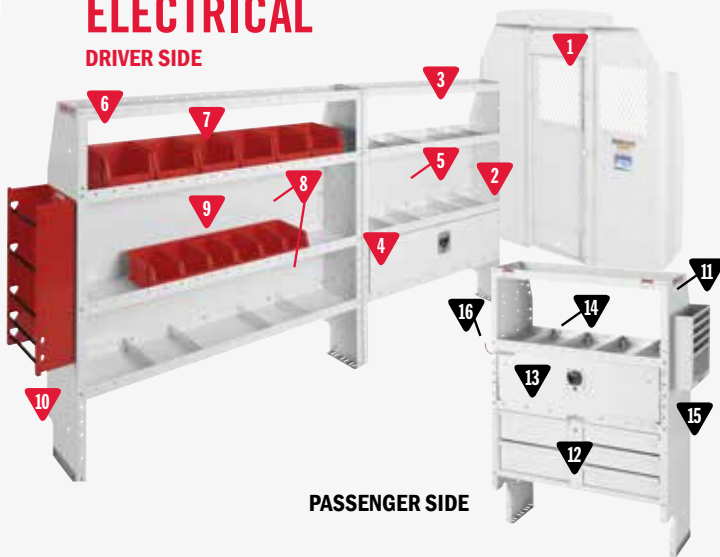

PASSENGER SIDE

600-8444L Electrical Package

| MODEL | DESCRIPTION | QUANTITY |
|-------|--|----------|
| 1 | 96142-3-01 Screen Bulkhead - ProMaster® | 1 |
| 2 | 96901-3-01 Swing Door Conversion Kit | 1 |
| 3 | 9375-3-03 Adjustable 4 Shelf Unit (52" x 60" x 13½") | 1 |
| 4 | 9505-3-01 Shelf Door (for 52" Shelf Unit) | 1 |
| 5 | 9605-3-01 Accessory Back Panel (for 52" Shelf Unit 14½" tall) | 2 |
| 6 | 9376-3-03 Adjustable 4 Shelf Unit (60" x 60" x 13½") | 1 |
| 7 | 9859-7-01 REDZONE Medium 6 Bin Set (13") | 1 |
| 8 | 9606-3-01 Accessory Back Panel (for 60" Shelf Unit 14½" tall) | 2 |
| 9 | 9858-7-01 REDZONE Small 6 Bin Set (13") | 1 |
| 10 | 9882-7-01 REDZONE Wire Spool Holder End Mount | 1 |
| 11 | 9391-3-03 Heavy Duty Shelf Unit (for Secure Storage Modules - 42" x 60" x 16") | 1 |
| 12 | 9045-3-02 5 Drawer Secure Storage Module (42" x 17" x 16") | 1 |
| 13 | 9504-3-01 Shelf Door (for 42" Shelf Unit) | 1 |
| 14 | 9604-3-01 Accessory Back Panel (for 42" Shelf Unit 14½" tall) | 1 |
| 15 | 9880-3-01 Literature Holder 6 Compartment | 1 |
| 16 | 9893-7-01 REDZONE 3 Hook Cord or Tool Holder | 1 |
| *17 | 975203-3-01 Van Shelf Mounting Kit - ProMaster 159" WB | 1 |

* Not Shown

HIGH ROOF PACKAGES 159" WB - EXTENDED LENGTH

Our Pro Packages help you organize your equipment and supplies, large and small. From recipis, drills and hand tools to expensive test equipment, the packages are customizable to meet your specific storage needs with a wide range of accessories starting on page 17.



NEW!

ProMaster High Roof Mounting Kit

- Heavy gauge steel mounting plates distribute shelf load and provide secure mounting to van interior
- Mounts directly to reinforced weld nuts and cargo tie-downs or into existing holes (no drilling)
- Faster installation with reduced risk of damage to van during installation

| MODEL | DESCRIPTION | WEIGHT |
|-------------|--|---------|
| 975204-3-01 | Promaster 159" Extended WB HR Mounting Kit | 27 lbs. |

COMMERCIAL / BASE

DRIVER SIDE

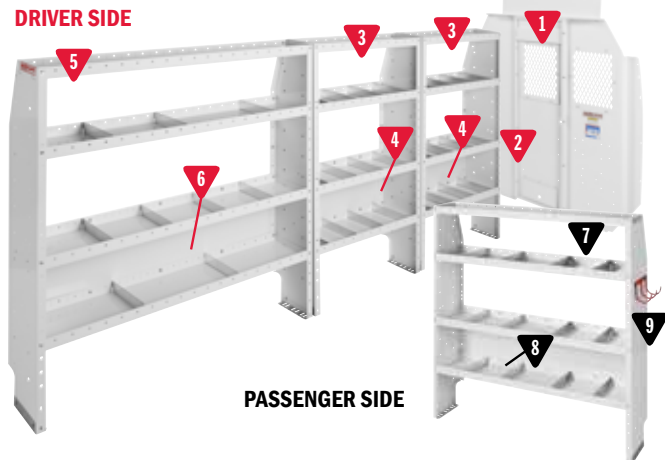

PASSENGER SIDE

600-8440X Commercial Shelving Package

| MODEL | DESCRIPTION | QUANTITY |
|-------|---|----------|
| 1 | 96142-3-01 Screen Bulkhead - ProMaster® | 1 |
| 2 | 96901-3-01 Swing Door Conversion Kit | 1 |
| 3 | 9373-3-03 Adjustable 4 Shelf Unit (36" x 60" x 13½") | 2 |
| 4 | 9603-3-01 Accessory Back Panel (for 36" Shelf Unit 14½" tall) | 2 |
| 5 | 9376-3-03 Adjustable 4 Shelf Unit (60" x 60" x 13½") | 1 |
| 6 | 9606-3-01 Accessory Back Panel (for 60" Shelf Unit 14½" tall) | 1 |
| 7 | 9376-3-03 Adjustable 4 Shelf Unit (60" x 60" x 13½") | 1 |
| 8 | 9606-3-01 Accessory Back Panel (for 60" Shelf Unit 14½" tall) | 1 |
| 9 | 9893-7-01 REDZONE 3 Hook Cord or Tool Holder | 1 |
| *10 | 975204-3-01 Van Shelf Mounting Kit - ProMaster 159" EXT WB | 1 |

* Not Shown

GENERAL SERVICE / CONTRACTOR

DRIVER SIDE

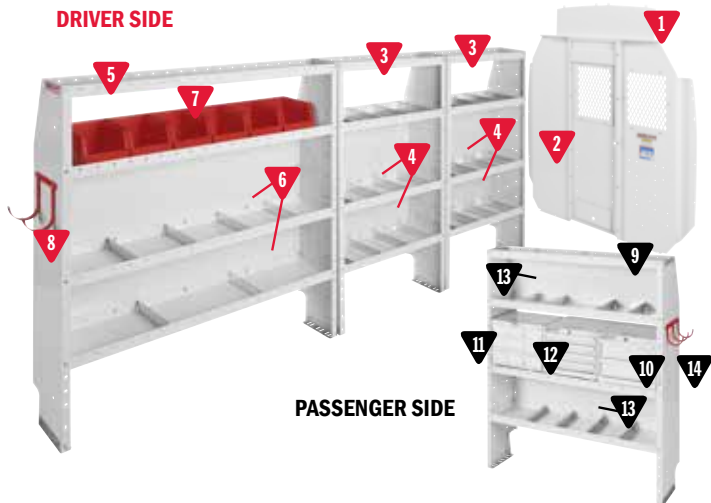

PASSENGER SIDE

600-8441X General Service/Contractor Package

| MODEL | DESCRIPTION | QUANTITY |
|-------|---|----------|
| 1 | 96142-3-01 Screen Bulkhead - ProMaster® | 1 |
| 2 | 96901-3-01 Swing Door Conversion Kit | 1 |
| 3 | 9373-3-03 Adjustable 4 Shelf Unit (36" x 60" x 13½") | 2 |
| 4 | 9603-3-01 Accessory Back Panel (for 36" Shelf Unit 14½" tall) | 4 |
| 5 | 9376-3-03 Adjustable 4 Shelf Unit (60" x 60" x 13½") | 1 |
| 6 | 9606-3-01 Accessory Back Panel (for 60" Shelf Unit 14½" tall) | 2 |
| 7 | 9859-7-01 REDZONE Medium 6 Bin Set (13") | 1 |
| 8 | 9892-7-01 REDZONE 2 Hook Holder (5" diameter) | 1 |
| 9 | 9375-3-03 Adjustable 4 Shelf Unit (52" x 60" x 13½") | 1 |
| 10 | 9912-3-02 2 Drawer Cabinet (16" x 14" x 12") | 1 |
| 11 | 9909-3-02 Parts Cabinet 9 Bin (16" x 12" x 12") | 1 |
| 12 | 9914-3-02 4 Drawer Cabinet (16" x 14" x 12") | 1 |
| 13 | 9605-3-01 Accessory Back Panel (for 52" Shelf Unit 14½" tall) | 2 |
| 14 | 9893-7-01 REDZONE 3 Hook Cord or Tool Holder | 1 |
| *15 | 975204-3-01 Van Shelf Mounting Kit - ProMaster 159" EXT WB | 1 |

* Not Shown

CABLE / PLUMBING

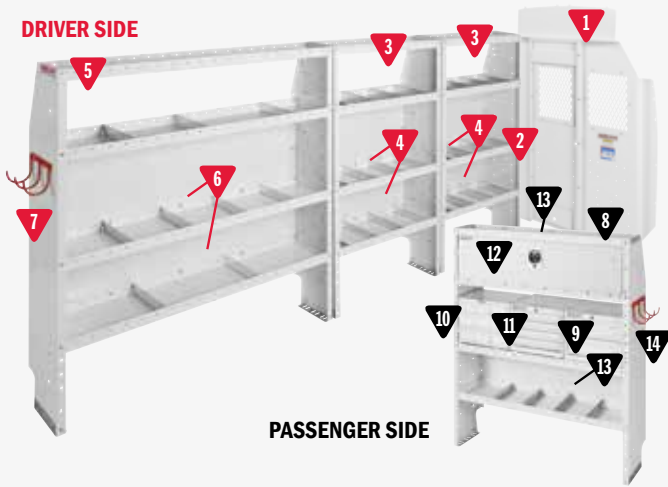

600-8442X Cable/Plumber Package

| MODEL | DESCRIPTION | QUANTITY |
|-------|---|----------|
| 1 | 96142-3-01 Screen Bulkhead - ProMaster® | 1 |
| 2 | 96901-3-01 Swing Door Conversion Kit | 1 |
| 3 | 9373-3-03 Adjustable 4 Shelf Unit (36" x 60" x 13½") | 2 |
| 4 | 9603-3-01 Accessory Back Panel (for 36" Shelf Unit 14½" tall) | 4 |
| 5 | 9376-3-03 Adjustable 4 Shelf Unit (60" x 60" x 13½") | 1 |
| 6 | 9606-3-01 Accessory Back Panel (for 60" Shelf Unit 14½" tall) | 2 |
| 7 | 9893-7-01 REDZONE 3 Hook Cord or Tool Holder | 1 |
| 8 | 9375-3-03 Adjustable 4 Shelf Unit (52" x 60" x 13½") | 1 |
| 9 | 9912-3-02 2 Drawer Cabinet (16" x 14" x 12") | 1 |
| 10 | 9909-3-02 Parts Cabinet 9 Bin (16" x 12" x 12") | 1 |
| 11 | 9914-3-02 4 Drawer Cabinet (16" x 14" x 12") | 1 |
| 12 | 9505-3-01 Shelf Door (for 52" Shelf Unit) | 1 |
| 13 | 9605-3-01 Accessory Back Panel (for 52" Shelf Unit 14½" tall) | 2 |
| 14 | 9893-7-01 REDZONE 3 Hook Cord or Tool Holder | 1 |
| *15 | 975204-3-01 Van Shelf Mounting Kit - ProMaster 159" EXT WB | 1 |

* Not Shown

HVAC / MECHANICAL

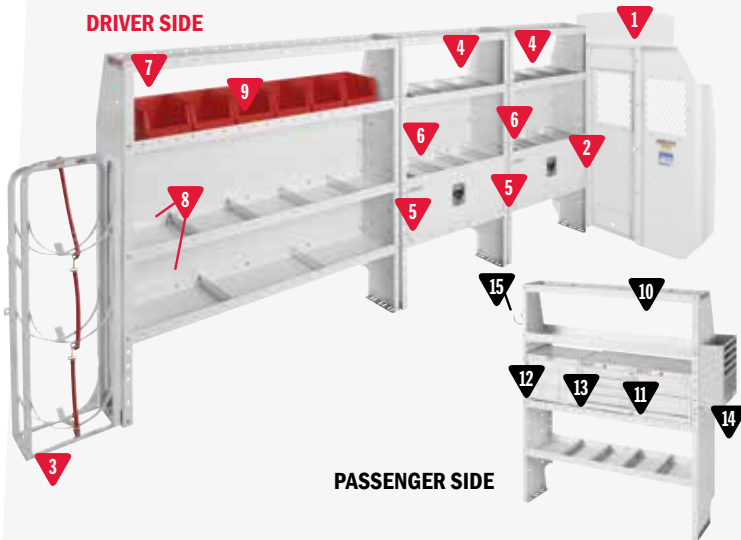

600-8443X HVAC/Mechanical Package

| MODEL | DESCRIPTION | QUANTITY |
|-------|---|----------|
| 1 | 96142-3-01 Screen Bulkhead - ProMaster® | 1 |
| 2 | 96901-3-01 Swing Door Conversion Kit | 1 |
| 3 | 9863-3-01 Refrigerant Tank Rack (2x 30#, 1x 50#) | 1 |
| 4 | 9373-3-03 Adjustable 4 Shelf Unit (36" x 60" x 13½") | 2 |
| 5 | 9503-3-01 Shelf Door (for 36" Shelf Unit) | 2 |
| 6 | 9603-3-01 Accessory Back Panel (for 36" Shelf Unit 14½" tall) | 4 |
| 7 | 9376-3-03 Adjustable 4 Shelf Unit (60" x 60" x 13½") | 1 |
| 8 | 9606-3-01 Accessory Back Panel (for 60" Shelf Unit 14½" tall) | 2 |
| 9 | 9859-7-01 REDZONE Medium 6 Bin Set (13") | 1 |
| 10 | 9375-3-03 Adjustable 4 Shelf Unit (52" x 60" x 13½") | 1 |
| 11 | 9912-3-02 2 Drawer Cabinet (16" x 14" x 12") | 1 |
| 12 | 9909-3-02 Parts Cabinet 9 Bin (16" x 12" x 12") | 1 |
| 13 | 9914-3-02 4 Drawer Cabinet (16" x 14" x 12") | 1 |
| 14 | 9880-3-01 Literature Holder 6 Compartment | 1 |
| 15 | 9893-7-01 REDZONE 3 Hook Cord or Tool Holder | 1 |
| *16 | 975204-3-01 Van Shelf Mounting Kit - ProMaster 159" EXT WB | 1 |

* Not Shown

ELECTRICAL

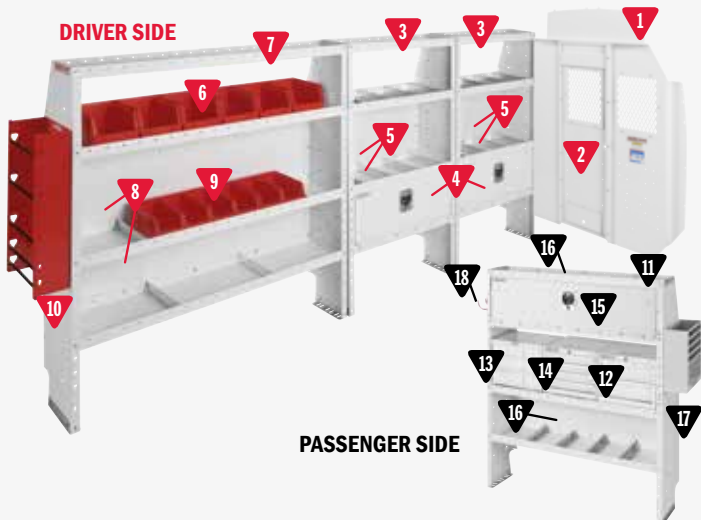

600-8444X Electrical Package

| MODEL | DESCRIPTION | QUANTITY |
|-------|---|----------|
| 1 | 96142-3-01 Screen Bulkhead - ProMaster® | 1 |
| 2 | 96901-3-01 Swing Door Conversion Kit | 1 |
| 3 | 9373-3-03 Adjustable 4 Shelf Unit (36" x 60" x 13½") | 2 |
| 4 | 9503-3-01 Shelf Door for 36" Shelf Unit | 2 |
| 5 | 9603-3-01 Accessory Back Panel (for 36" Shelf Unit 14½" tall) | 4 |
| 6 | 9859-7-01 REDZONE Medium 6 Bin Set 13" | 1 |
| 7 | 9376-3-03 Adjustable 4 Shelf Unit (60" x 60" x 13½") | 1 |
| 8 | 9606-3-01 Accessory Back Panel (for 60" Shelf Unit 14½" tall) | 2 |
| 9 | 9858-7-01 REDZONE Small 6 Bin Set (13") | 1 |
| 10 | 9882-7-01 REDZONE Wire Spool Holder End Mount | 1 |
| 11 | 9375-3-03 Adjustable 4 Shelf Unit (52" x 13½" x 60") | 1 |
| 12 | 9912-3-02 2 Drawer Cabinet (16" x 14" x 12") | 1 |
| 13 | 9909-3-02 Parts Cabinet 9 Bin (16" x 12" x 12") | 1 |
| 14 | 9914-3-02 4 Drawer Cabinet (16" x 14" x 12") | 1 |
| 15 | 9505-3-01 Shelf Door (for 52" Shelf Unit) | 1 |
| 16 | 9605-3-01 Accessory Back Panel (52" x 14½" high) | 2 |
| 17 | 9880-3-01 Literature Holder 6 Compartment | 1 |
| 18 | 9893-7-01 REDZONE 3 Hook Cord or Tool Holder | 1 |
| *19 | 975204-3-01 Van Shelf Mounting Kit - ProMaster 159" EXT WB | 1 |

* Not Shown

PROMASTER CITY PACKAGES



Keep it simple with room for the busiest days or fully load it up with shelves, drawers and bins to keep everything organized. Your ProMaster City works just as hard any other van on the road. Customize for your needs with accessories starting on page 17.

ProMaster City Mounting Kit

- Heavy gauge steel mounting plates distribute shelf load and provide secure mounting to van interior
- Mounts directly to reinforced weld nuts and cargo tie-downs or into existing holes (no drilling)
- Faster installation with reduced risk of damage to van during installation

| MODEL | DESCRIPTION | WEIGHT |
|-------------|-----------------------------|---------|
| 9752-3-01 | Rear Shelf Mounting Kit | 15 lbs. |
| 975205-3-01 | Driver Side Mounting Kit | 15 lbs. |
| 975206-3-01 | Passenger Side Mounting Kit | 19 lbs. |

COMMERCIAL / BASE

DRIVER SIDE

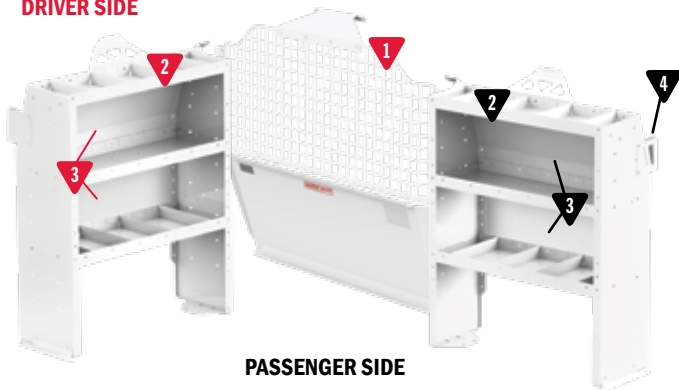

PASSENGER SIDE

600-8340 Commercial Shelving Package

| MODEL | DESCRIPTION | QUANTITY |
|-------|--|----------|
| 1 | 96112-3-01 Mesh Bulkhead - ProMaster City™ | 1 |
| 2/2 | 9353-3-03 Adjustable 3 Shelf Unit (36" x 44" x 13½") | 2 |
| 3/3 | 9603-3-01 Accessory Back Panel (36" x 14½") | 4 |
| 4 | 9752-3-01 Rear Shelving Mounting Kit - ProMaster City™ | 1 |

GENERAL SERVICE

DRIVER SIDE

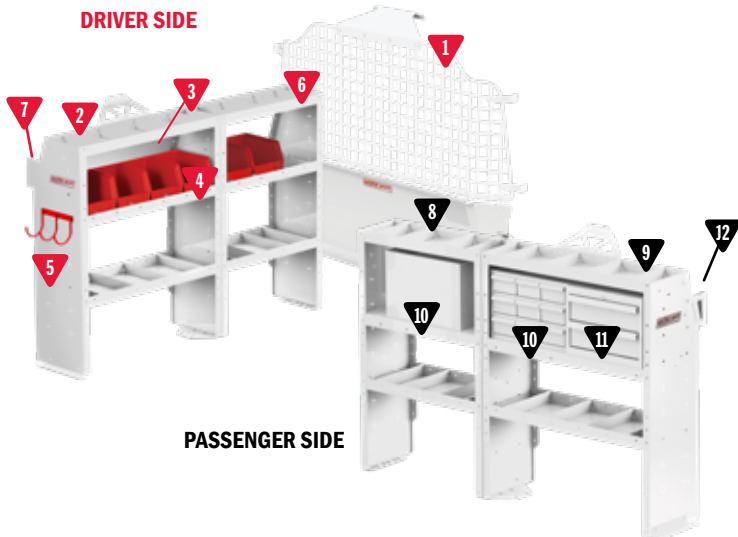

PASSENGER SIDE

600-8341 General Service Package

| MODEL | DESCRIPTION | QUANTITY |
|-------|---|----------|
| 1 | 96112-3-01 Mesh Bulkhead - ProMaster City™ | 1 |
| 2 | 9353-3-03 Adjustable 3 Shelf Unit (36" x 44" x 13½") | 1 |
| 3 | 9603-3-01 Accessory Back Panel (36" x 14½") | 1 |
| 4 | 9859-7-01 REDZONE Medium 6 Bin Set (13") | 1 |
| 5 | 9893-7-01 REDZONE 3 Hook Cord or Tool Holder | 1 |
| 6 | 9352-3-03 Adjustable 3 Shelf Unit (28" x 44" x 13½") | 1 |
| 7 | 975205-3-01 Mounting Kit - ProMaster City™ Driver Side | 1 |
| 8 | 9352-3-03 Adjustable 3 Shelf Unit (28" x 44" x 13½") | 1 |
| 9 | 9353-3-03 Adjustable 3 Shelf Unit (36" x 44" x 13½") | 1 |
| 10 | 9909-3-02 Parts Cabinet 9 Bin Set (16" x 14" x 12") | 2 |
| 11 | 9912-3-02 2 Drawer Cabinet (16" x 14" x 12") | 1 |
| 12 | 975206-3-01 Mounting Kit - ProMaster City™ Passenger Side | 1 |

PLUMBING

600-8342 Plumbing Package

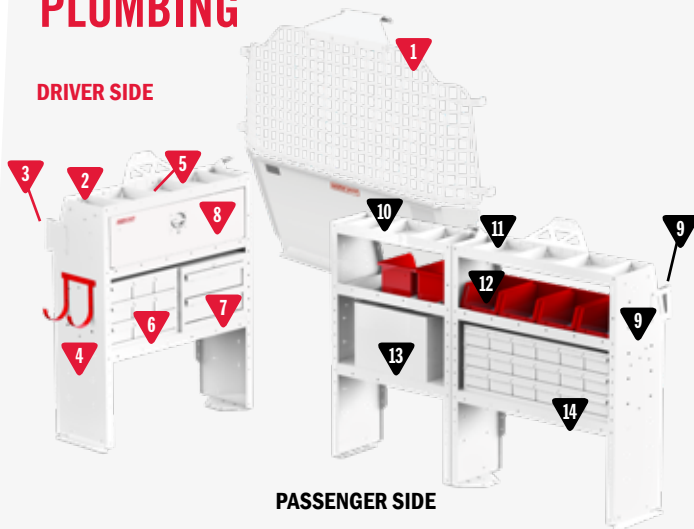

| MODEL | DESCRIPTION | QUANTITY |
|-------|---|----------|
| 1 | 96112-3-01 Mesh Bulkhead - ProMaster City™ | 1 |
| 2 | 9353-3-03 Adjustable 3 Shelf Unit (36" x 36" x 13½") | 1 |
| 3 | 975205-3-01 Driver Side Mounting Kit - ProMaster City™ | 1 |
| 4 | 9892-7-01 REDZONE 2 Hook Holder (5" diameter) | 1 |
| 5 | 9603-3-01 Accessory Back Panel (for 36" Shelf Unit 14½" tall) | 1 |
| 6 | 9909-3-02 Parts Cabinet 9 Bin (16" x 12" x 12") | 1 |
| 7 | 9912-3-02 2 Drawer Cabinet (16" x 14" x 12") | 1 |
| 8 | 9503-3-01 Shelf Door (for 36" Shelf Unit) | 1 |
| 9 | 975206-3-01 Passenger Side Mounting Kit - ProMaster City™ | 1 |
| 10 | 9352-3-03 Adjustable 3 Shelf Unit (28" x 44" x 13½") | 1 |
| 11 | 9353-3-03 Adjustable 3 Shelf Unit (36" x 44" x 13½") | 1 |
| 12 | 9859-7-01 REDZONE Medium 6 Bin Set (13") | 1 |
| 13 | 9909-3-02 Parts Cabinet 9 Bin (16" x 12" x 12") | 1 |
| 14 | 9918-3-02 Parts Cabinet 18 Bin (32" x 12" x 12") | 1 |

HVAC / MECHANICAL

600-8343 HVAC/Mechanical Package

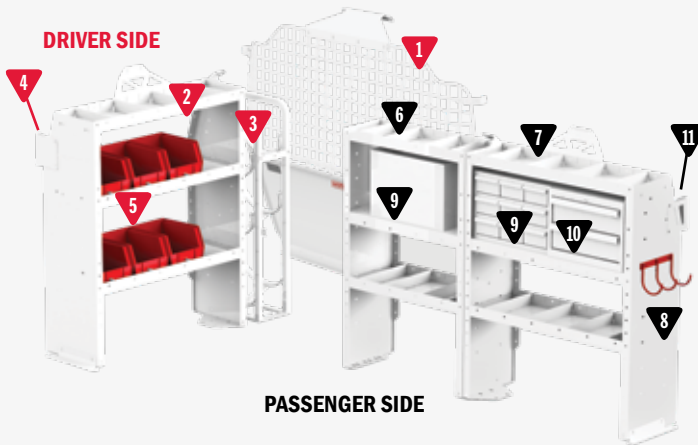

| MODEL | DESCRIPTION | QUANTITY |
|-------|---|----------|
| 1 | 96112-3-01 Mesh Bulkhead - ProMaster City™ | 1 |
| 2 | 9353-3-03 Adjustable 3 Shelf Unit (36" x 36" x 13½") | 1 |
| 3 | 9863-3-01 Refrigerant Tank Rack (1 x 50 lbs., 2 x 30lbs.) | 1 |
| 4 | 975205-3-01 Driver Side Mounting Kit - ProMaster City™ | 1 |
| 5 | 9859-7-01 REDZONE Medium 6 Bin Set (7" x 8" x 12") | 1 |
| 6 | 9352-3-03 Adjustable 3 Shelf Unit (28" x 44" x 13½") | 1 |
| 7 | 9353-3-03 Adjustable 3 Shelf Unit (36" x 44" x 13½") | 1 |
| 8 | 9893-7-01 REDZONE 3 Hook Cord or Tool Holder | 1 |
| 9 | 9909-3-02 Parts Cabinet 9 Bin (16" x 12" x 12") | 2 |
| 10 | 9912-3-02 2 Drawer Cabinet (16" x 14" x 12") | 1 |
| 11 | 975206-3-01 Passenger Side Mounting Kit - ProMaster City™ | 1 |

ELECTRICAL

600-8344 Electrical Package

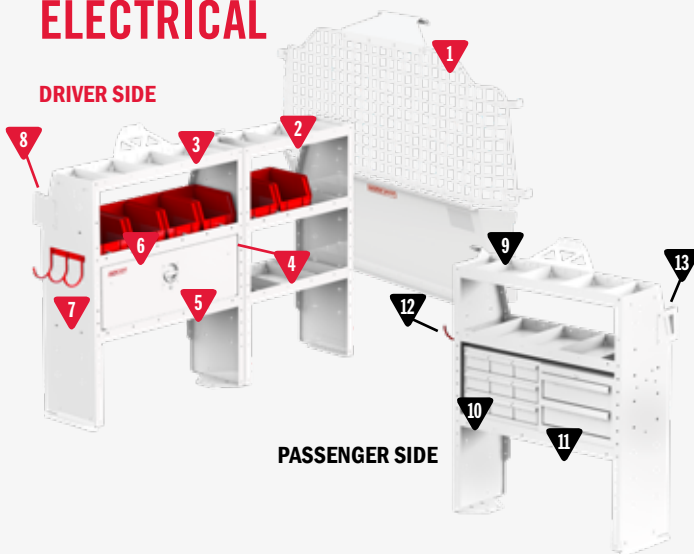

| MODEL | DESCRIPTION | QUANTITY |
|-------|---|----------|
| 1 | 96112-3-01 Mesh Bulkhead - ProMaster City™ | 1 |
| 2 | 9352-3-03 Adjustable 3 Shelf Unit (28" x 44" x 13½") | 1 |
| 3 | 9353-3-03 Adjustable 3 Shelf Unit (36" x 44" x 13½") | 1 |
| 4 | 9603-3-01 Accessory Back Panel (for 36" Shelf Unit 14½" tall) | 1 |
| 5 | 9503-3-01 Shelf Door (for 36" Shelf Unit) | 1 |
| 6 | 9859-7-01 REDZONE Medium 6 Bin Set 13" | 1 |
| 7 | 9893-7-01 REDZONE 3 Hook Cord or Tool Holder | 1 |
| 8 | 975205-3-01 Driver Side Mounting Kit - ProMaster City™ | 1 |
| 9 | 9353-3-03 Adjustable 3 Shelf Unit (36" x 44" x 13½") | 1 |
| 10 | 9909-3-02 Parts Cabinet 9 Bin (16" x 12" x 12") | 1 |
| 11 | 9912-3-02 2 Drawer Cabinet (16" x 14" x 12") | 1 |
| 12 | 9893-7-01 REDZONE 3 Hook Cord or Tool Holder | 1 |
| 13 | 975206-3-01 Passenger Side Mounting Kit - ProMaster City™ | 1 |

BULKHEADS

WEATHER GUARD® Van Bulkheads separate the driver compartment from the cargo area for maximum protection against shifting loads. Polycarbonate windows reduce noise and provide visibility through the bulkhead. The angled design cuts glare to improve visibility and safety. Bulkhead accessories are available to make the most of organization space in your van. Deep offset bulkheads provide superior comfort in the cab area allowing full seat travel.

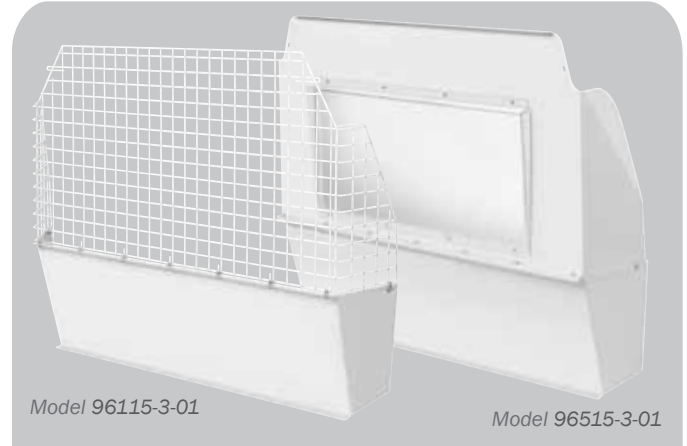

Bulkhead for Ram ProMaster®

Improved visibility, safety, and security for occupants and cargo protection. Exclusive design fits both Standard and High Roof Ram ProMaster®.

| MODEL | DESCRIPTION | WEIGHT |
|------------|--|----------|
| 96141-3-01 | Polycarbonate Window Bulkhead | 105 lbs. |
| 96142-3-01 | Steel Mesh Screen Bulkhead | 105 lbs. |
| 96901-3-01 | Hinge Kit converts bulkhead to swinging door with lockable latch | 4 lbs. |
| 96903-3-01 | Solid Bulkhead Panel Adapter Kit | 10 lbs. |

Bulkhead for C/V Tradesman®

Options provide protection, prevent unauthorized access, and offer excellent visibility of the cargo area from the passenger compartment.

| MODEL | DESCRIPTION | WEIGHT |
|------------|--|---------|
| 96115-3-01 | Lightweight Mesh Bulkhead | 35 lbs. |
| 96515-3-01 | Window Bulkhead (maximizes front seat comfort) | 40 lbs. |



Bulkhead for Ram ProMaster City™

Window bulkheads offer unobstructed visibility of the cargo area, side door, and rear door. Maximizes comfort in the passenger area. Lightweight mesh bulkheads deliver full driver and cargo protection.

| MODEL | DESCRIPTION | WEIGHT |
|------------|--------------------------------------|---------|
| 96112-3-01 | Mesh Bulkhead, Ram ProMaster City™ | 35 lbs. |
| 96512-3-01 | Window Bulkhead, Ram ProMaster City™ | 40 lbs. |

Bulkhead Accessories

Improve organization and productivity with easy to install accessories.

| MODEL | DESCRIPTION | WEIGHT |
|--------------|----------------------------------|---------|
| 1 8875 | Hard Hat Bracket | 2 lbs. |
| 2 8866 | Fire Extinguisher | 6 lbs. |
| 3 9879-7-01 | Tool Organizer | 4 lbs. |
| 4 96901-3-01 | Optional Hinge Kit | 4 lbs. |
| 5 96903-3-01 | Solid Steel Panel Conversion Kit | 10 lbs. |

ADJUSTABLE SHELVING

17° TAPERED END PANEL CLOSER FIT

for more working space inside the van

DEEP FULLY HEMMED SHELVES

sized for tools, equipment, and other materials

EASY TO CUSTOMIZE

with pre-punched mounting holes for WEATHER GUARD® accessories and cabinets

EASY TO ASSEMBLE AND "STALL"

with captive nuts on each shelf and complete "stallation" hardware



ADJUSTABLE DIVIDERS

Includes pack of four adjustable dividers for each shelf

PUNCHED SHELVES

for easier "stallation" of accessory cabinets

FRONT FLOOR CLEARANCE (16" SHELVES ONLY)

for material storage. Fits PACK RAT® Drawer Units

UNMATCHED DURABILITY

achieved with heavy duty 18 gauge steel construction

FLAT FRONTS

on 13-1/2" deep adjustable shelves. Mount doors and accessories at floor level

WEATHER GUARD® EXCLUSIVE!



Shelf Units: Ships complete in one carton

| MODEL | HEIGHT | WIDTH | DEPTH | SHELVES | DIVIDERS | WEIGHT |
|-----------------------|--------|-------|-------|---------|----------|----------|
| 9333-3-03 | 34" | 36" | 13½" | 2 | 8 | 48 lbs. |
| 9334-3-03 | 34" | 42" | 13½" | 2 | 8 | 48 lbs. |
| 9335-3-03 | 34" | 52" | 13½" | 2 | 8 | 72 lbs. |
| 9336-3-03 | 34" | 60" | 13½" | 2 | 8 | 70 lbs. |
| 9343-3-03 | 44" | 36" | 16" | 3 | 12 | 74 lbs. |
| 9344-3-03 | 44" | 42" | 16" | 3 | 12 | 80 lbs. |
| 9345-3-03 | 44" | 52" | 16" | 3 | 12 | 85 lbs. |
| 9346-3-03 | 44" | 60" | 16" | 3 | 12 | 104 lbs. |
| NEW! 9352-3-03 | 44" | 28" | 13½" | 3 | 12 | 50 lbs. |
| 9353-3-03 | 44" | 36" | 13½" | 3 | 12 | 53 lbs. |
| 9354-3-03 | 44" | 42" | 13½" | 3 | 12 | 57 lbs. |
| 9355-3-03 | 44" | 52" | 13½" | 3 | 12 | 66 lbs. |
| 9356-3-03 | 44" | 60" | 13½" | 3 | 12 | 73 lbs. |
| 9363-3-03 | 60" | 36" | 16" | 4 | 16 | 92 lbs. |
| 9364-3-03 | 60" | 42" | 16" | 4 | 16 | 94 lbs. |
| 9365-3-03 | 60" | 52" | 16" | 4 | 16 | 110 lbs. |
| 9366-3-03 | 60" | 60" | 16" | 4 | 16 | 136 lbs. |
| 9373-3-03 | 60" | 36" | 13½" | 4 | 16 | 76 lbs. |
| 9374-3-03 | 60" | 42" | 13½" | 4 | 16 | 94 lbs. |
| 9375-3-03 | 60" | 52" | 13½" | 4 | 16 | 110 lbs. |
| 9376-3-03 | 60" | 60" | 13½" | 4 | 16 | 136 lbs. |

24" Deep Jumbo Shelving Items

Extra deep 24" shelving constructed of 18-gauge steel and finished with durable brite white powder coat. These shelves are easy to assemble and provide the perfect foundation for a customized van or trailer. Special order only, with longer lead times.



| MODEL | HEIGHT | WIDTH | DEPTH | SHELVES |
|-----------|-------------------------------------|-------|-------|---------|
| 8393-3-01 | 59½" | 42¼" | 24" | 3 |
| 8394-3-01 | 59½" | 51¼" | 24" | 3 |
| 8395-3-01 | 59½" | 69¼" | 24" | 3 |
| 8118-3-01 | Short Bin Dividers for 24"D Shelves | | | |

NEW ITEMS AVAILABLE JUNE 2018



SECURE STORAGE

Add extra security and theft-resistance for valuable tools and equipment with WEATHER GUARD® Secure Storage shelf units. Multiple door and drawer modules easily assemble into shelving. Our welded steel construction and heavy-duty locking mechanism ensures peace of mind on the job or in the parking lot.

! HIGH SECURITY
welded steel box and shelf construction

! UNMATCHED ORGANIZATION & EFFICIENCY
with no wasted space below or between drawers

! UNMATCHED DURABILITY
box construction strengthens and rigidizes shelf unit

! EXTRA LARGE STEEL DRAWERS
17"x14"x4" or 6" with ball bearing slides rated at 75 pounds per drawer

! FAST AND EASY ASSEMBLY
modules bolt to end panels. Add top shelf to complete unit.

! FULLY FUNCTIONAL 16" SECURE MODULE TOP
designed like a 16" shelf for additional storage



WEATHER GUARD® EXCLUSIVE! **!**

Select the shelf unit to fit your van, then the storage module to fit your needs.

Secure Storage Shelf Units (42" Wide)

| MODEL | | HEIGHT | DIVIDERS | WEIGHT |
|---|-----------------|--------|----------|----------|
| 9381-3-03 | Full Size Vans | 44" | 8 | 104 lbs. |
| Includes end panel and top shelf for secure storage unit | | | | |
| 9391-3-03 | High Roof Vans | 60" | 12 | 108 lbs. |
| Includes end panels, top and center shelf for secure storage unit | | | | |
| 9040-3-01 | Door Module | | | 47 lbs. |
| 9045-3-02 | 5 Drawer Module | | | 78 lbs. |

Secure Storage Service Parts

| MODEL | DESCRIPTION | WEIGHT |
|----------|--------------------------|----------|
| 70206-xx | Replacement Lock Kit | 117 lbs. |
| 70210-xx | Key Kit | 1 lb. |
| 70211-xx | Replacement D Handle Kit | 1 lb. |

xx- Designates key code
Specify key code 11-20 when ordering



Door Module
9040-3-01



5 Drawer
Module
9045-3-02

ACCESSORIES



Shelf Doors with High Security D Handle Lock
Mount to shelf units or to retainer lips. Single point D-handle lock for added security. Allow seven mounting holes shelf to shelf spacing

| MODEL | HEIGHT | SHELF WIDTH | WEIGHT |
|-----------------------|--------|-------------|---------|
| NEW! 9502-3-01 | 11" | 28" | 10 lbs. |
| 9503-3-01 | 11" | 36" | 13 lbs. |
| 9504-3-01 | 11" | 42" | 17 lbs. |
| 9505-3-01 | 11" | 52" | 21 lbs. |
| 9506-3-01 | 11" | 60" | 25 lbs. |

Light Weight Shelf Back Panels
Use with shelf doors to turn a shelf into a cabinet

| MODEL | HEIGHT | SHELF WIDTH | WEIGHT |
|-----------------------|--------|-------------|---------|
| NEW! 9602-3-02 | 7¾" | 28" | 2 lbs. |
| 9603-3-02 | 7¾" | 36" | 2 lbs. |
| 9604-3-02 | 7¾" | 42" | 3 lbs. |
| 9605-3-02 | 7¾" | 52" | 4 lbs. |
| 9606-3-02 | 7¾" | 60" | 5 lbs. |
| NEW! 9602-3-01 | 14½" | 28" | 4 lbs. |
| 9603-3-01 | 14½" | 36" | 4 lbs. |
| 9604-3-01 | 14½" | 42" | 6 lbs. |
| 9605-3-01 | 14½" | 52" | 8 lbs. |
| 9606-3-01 | 14½" | 60" | 10 lbs. |

Retainer Lips
Keeps items in place under shelf units

| MODEL | HEIGHT | SHELF WIDTH | DEPTH | WEIGHT |
|-----------------------|--------|-------------|-------|--------|
| NEW! 9702-3-02 | 1½" | 28" | 1½" | 1 lb. |
| 9703-3-02 | 1½" | 36" | 1½" | 1 lb. |
| 9704-3-02 | 1½" | 42" | 1½" | 1 lb. |
| 9705-3-02 | 1½" | 52" | 1½" | 2 lbs. |
| 9706-3-02 | 1½" | 60" | 1½" | 2 lbs. |

End Panels
Can't find the shelf combination you need? Configure your own shelf system with end panels and accessory shelves.

| MODEL | HEIGHT | WIDTH | DEPTH | WEIGHT |
|-----------|--------|-------|-------|---------|
| 9243-3-01 | 36" | 2" | 13½" | 22 lbs. |
| 9244-3-01 | 44" | 2" | 13½" | 18 lbs. |
| 9246-3-01 | 60" | 2" | 13½" | 33 lbs. |
| 9274-3-01 | 44" | 2" | 16" | 30 lbs. |
| 9276-3-01 | 60" | 2" | 16" | 34 lbs. |

Extra Shelves
Includes one set of dividers

| MODEL | HEIGHT | WIDTH | DEPTH | WEIGHT |
|-----------------------|--------|-------|-------|---------|
| NEW! 9142-3-01 | 2" | 28" | 13½" | 10 lbs. |
| 9143-3-01 | 2" | 36" | 13½" | 14 lbs. |
| 9144-3-01 | 2" | 42" | 13½" | 18 lbs. |
| 9145-3-01 | 2" | 52" | 13½" | 22 lbs. |
| 9146-3-01 | 2" | 60" | 13½" | 26 lbs. |
| 9163-3-01 | 2" | 36" | 16" | 14 lbs. |
| 9164-3-01 | 2" | 42" | 16" | 18 lbs. |
| 9165-3-01 | 2" | 52" | 16" | 22 lbs. |
| 9166-3-01 | 2" | 60" | 16" | 26 lbs. |



Locking Storage & CATV Cabinets

| MODEL | SHELVES | HEIGHT | WIDTH | DEPTH | WEIGHT |
|--------------------|---------|--------|-------|-------|---------|
| 1 9020-3-01 | N/A | 22" | 18" | 16" | 25 lbs. |
| 2 9021-3-01 | 2* | 22" | 18" | 16" | 35 lbs. |

*Removable Shelves



Bin Sets
Sturdy plastic bins sized to fit 16" or 13" deep adjustable van shelving

| MODEL | HEIGHT | WIDTH | DEPTH | BINS | WEIGHT |
|-----------|--------|-------|-------|------|---------|
| 9854-7-01 | 5" | 5½" | 14¾" | 9 | 8 lbs. |
| 9855-7-01 | 7" | 8¼" | 14¾" | 6 | 10 lbs. |
| 9856-7-01 | 7" | 16½" | 14¾" | 3 | 8 lbs. |
| 9858-7-01 | 5" | 5½" | 10⅞" | 6 | 8 lbs. |
| 9859-7-01 | 7" | 7" | 10⅞" | 6 | 8 lbs. |



Model 89011

Van Floor Mats
Designed to cover seating wells in the van floor. Required when installing bulkhead units and other equipment.

| MODEL | VAN TYPE | WHEELBASE | WEIGHT |
|-------|--|---------------|---------|
| 89011 | 70" x 124" rectangular (must be cut to fit any style vans) | | 55 lbs. |
| 89020 | '14 & Newer Ram ProMaster® | 118" | 32 lbs. |
| 89021 | '14 & Newer Ram ProMaster® | 136" | 39 lbs. |
| 89022 | '14 & Newer Ram ProMaster® | 158" | 46 lbs. |
| 89023 | '14 & Newer Ram ProMaster® | 158" Extended | 49 lbs. |

NEW ITEMS AVAILABLE JUNE 2018



ACCESSORIES

GRAB & GO TOOL CART

Our new, modular 3-piece rolling tool chest puts those tools and parts used on every job at your fingertips. Heavy-duty construction keeps your productivity rolling for years to come.

- Modular, 3-piece rolling tool chest
- Removable tool box with steel tray
- Sliding drawer unit
- Tilt-out storage bin
- Telescoping handle



Grab & Go Tool Cart

| MODEL | HEIGHT | WIDTH | DEPTH | BOXES | WEIGHT |
|-----------|--------|-------|-------|-------|---------|
| 9953-7-01 | 28½" | 20" | 12" | 3 | 24 lbs. |



Floor Mounted Accessories

| MODEL | DESCRIPTION | HEIGHT | WIDTH | DEPTH | WEIGHT |
|-------|--|--------|-------|-------|---------|
| 1 | 9861-3-01 Cable Spool Holder | 42½" | 19¾" | 16¾" | 37 lbs. |
| 2 | 9864-3-01 4-30 lb. Tank Holder | 48½" | 13" | 8" | 31 lbs. |
| 3 | 9863-3-01 2-30 lb., 1-50 lb. Tank Holder | 40" | 15½" | 8" | 27 lbs. |
| 4 | 9862-3-01 3-50 lb. Tank Holder | 45½" | 15½" | 8" | 31 lbs. |
| 5 | 9860-3-01 Catalog File Unit | 36" | 6" | 12" | 16 lbs. |
| 6 | 9885-7-01 5 Gal. Bucket Holder | 6¼" | 11¼" | 11¼" | 8 lbs. |



Door Trays and Literature Holders

| MODEL | HEIGHT | WIDTH | DEPTH | WEIGHT | |
|-------|-----------|-------|-------|--------|---------|
| 1 | 9871-3-01 | 21¾" | 20¼" | 4⅝" | 19 lbs. |
| 2 | 9872-3-01 | 21¾" | 20¼" | 4⅝" | 18 lbs. |
| 3 | 9873-3-01 | 21¾" | 20¼" | 4⅝" | 19 lbs. |
| 4 | 9880-3-01 | 16" | 13" | 5" | 11 lbs. |

REDZONE ACCESSORIES

Looking for parts and supplies won't slow you down with new and re-engineered REDZONE van storage accessories. Organizers and holders keep frequently used items in easy reach for maximum productivity. Tool cabinets, parts bin boxes, and locking storage keep small components organized.

CUSTOMIZED ORGANIZATION
for supplies and tools

HEAVY DUTY 18 GAUGE STEEL CONSTRUCTION
makes for tough, long lasting accessories

POWDER COAT FINISH
provides durability

EASY TO INSTALL
to shelf end panels, bulkheads, and door



HOOKS AND BRACKETS



REDZONE Accessories

| | MODEL | DESCRIPTION | HEIGHT | WIDTH | DEPTH | WEIGHT |
|----|-----------|-----------------------------|--------|-------|-------|---------|
| 1 | 9874-7-01 | Can Organizer | 9.8" | 12" | 4" | 3 lbs. |
| 2 | 9879-7-01 | Tool Organizer | 5½" | 15" | 4" | 3 lbs. |
| 3 | 9881-7-01 | Caulk Tube Tray | 7½" | 13½" | 7½" | 4¼ lbs. |
| 4 | 9882-7-01 | Wire Spool Holder End Mount | 26" | 14" | 6" | 12 lbs. |
| 5 | 9883-7-01 | Large Parts Bin | 11" | 13" | 7" | 10 lbs. |
| 6 | 9884-7-01 | Medium Parts Bin | 6½" | 13" | 7" | 8 lbs. |
| 7 | 9885-7-01 | 5 Gallon Bucket Holder | 6¼" | 11¼" | 11¼" | 8 lbs. |
| 8 | 9886-7-01 | 30# Refrigerant Tank Holder | 10¾" | 9¾" | 9¾" | 9 lbs. |
| 9 | 9887-7-01 | Ladder Holder | 4" | 1½" | 3½" | ¼ lb. |
| 10 | 9891-7-01 | Large Hook (5" diameter) | 8" | 1¼" | 5" | ½ lb. |
| 11 | 9892-7-01 | 2 Hook Holder (5" diameter) | 8" | 9" | 5" | ½ lb. |
| 12 | 9893-7-01 | 3 Hook Cord or Tool Holder | 5¼" | 9" | 4½" | ½ lb. |

CABINETS



Mechanics Grade Tool Cabinets

High quality and durable mechanics-grade Tool Cabinets for your van feature easy-to-grip handles, smooth ball-bearing rollers, latches for each drawer, and secure locks that can be keyed alike. Bin Cabinets feature hook and loop fasteners to securely hold bins in place.

| | MODEL | DRAWERS | HEIGHT | WIDTH | DEPTH | WEIGHT |
|---|-----------|---------|--------|-------|-------|---------|
| 1 | 9912-3-02 | 2 | 12" | 16" | 13.7" | 26 lbs. |
| 2 | 9914-3-02 | 4 | 12" | 16" | 13.7" | 32 lbs. |
| 3 | 9924-3-02 | 4 | 24" | 16" | 13.7" | 48 lbs. |
| 4 | 9928-3-02 | 8 | 24" | 16" | 13.7" | 60 lbs. |
| 5 | 9984-3-01 | 4 | 24" | 18" | 13.7" | 53 lbs. |
| 6 | 9988-3-01 | 8 | 24" | 18" | 13.7" | 60 lbs. |

Cabinet Divider Kits

| MODEL | DESCRIPTION | WEIGHT |
|-----------|--|--------|
| 9822-3-01 | Divider and Liner Kit for 9914-3-02, 9928-3-02 | 2 lbs. |
| 9824-3-01 | Divider and Liner Kit for 9912-3-02, 9924-3-02 | 2 lbs. |



Parts Boxes & Bin Cabinets

| | MODEL | BINS | HEIGHT | WIDTH | DEPTH | WEIGHT |
|---|------------|------|--------|-------|-------|---------|
| 1 | 9906-3-02 | 6 | 4½" | 32½" | 11¾" | 18 lbs. |
| 2 | 9909-3-02 | 9 | 12" | 17" | 11¾" | 28 lbs. |
| 3 | 9918-3-02 | 18 | 12" | 32½" | 11¾" | 54 lbs. |
| 4 | 9950-7-02* | N/A | 12.6" | 20.3" | 14.4" | 4 lbs. |
| 5 | 9951-9-01 | N/A | 3" | 18½" | 13" | 3 lbs. |
| Special Order Cabinets (Call for availability. Longer lead time required) | | | | | | |
| 6 | 8908-3 | 8 | 8½" | 22 " | 11¾" | 24 lbs. |

*Parts cases not included



1 Invert shelf when assembling it and mount cabinet directly to shelf.

2 Keep shelf facing up and use Cabinet Mounting Spacer kit Model 9994. Order separately.

Cabinet Accessory Mounting

The new van shelf design includes cabinet mounting holes that make it easier to assemble and install. There are two fast ways to mount cabinet and parts boxes to van shelves.

| MODEL | DESCRIPTION | WEIGHT |
|-----------|------------------------------------|--------|
| 9994 | Shelf Cabinet Mounting Kit | 1 lb. |
| 9996-3-01 | Shelf Accessory Mounting Kit (16") | 1 lb. |

DRAWER UNITS



PACK RAT® Drawer Units

| MODEL | HEIGHT | WIDTH | DEPTH | COMPARTMENTS | DIVIDERS | WEIGHT |
|------------------------------|--------|-------|-------|--------------|----------|----------|
| STEEL DRAWER UNITS | | | | | | |
| 301-3 | 12½" | 30" | 24" | 3 | 12 | 169 lbs. |
| 303-3 | 12½" | 39¾" | 24" | 4 | 12 | 217 lbs. |
| 304-3 | 9" | 30" | 48" | 2 | 6 | 220 lbs. |
| 305-3 | 9" | 10¼" | 48" | 1 | 6 | 106 lbs. |
| 306-3 | 9" | 20" | 48" | 2 | 12 | 179 lbs. |
| 307-3 | 9" | 30" | 48" | 3 | 18 | 247 lbs. |
| 308-3 | 9" | 39¾" | 48" | 4 | 24 | 322 lbs. |
| 308-5 | 9" | 39¾" | 48" | 4 | 24 | 322 lbs. |
| 312-3 | 9" | 30" | 24" | 3 | 12 | 151 lbs. |
| 334-3 | 12½" | 30" | 48" | 2 | 6 | 245 lbs. |
| 335-3 | 12½" | 10¼" | 48" | 1 | 6 | 130 lbs. |
| 336-3 | 12½" | 20" | 48" | 2 | 12 | 210 lbs. |
| 337-3 | 12½" | 30" | 48" | 3 | 18 | 294 lbs. |
| 338-3 | 12½" | 39¾" | 48" | 4 | 24 | 383 lbs. |
| 338-5 | 12½" | 39¾" | 48" | 4 | 24 | 383 lbs. |
| ALUMINUM DRAWER UNITS | | | | | | |
| 310-3-01 | 14½" | 11¾" | 42" | 1 | 0 | 56 lbs. |

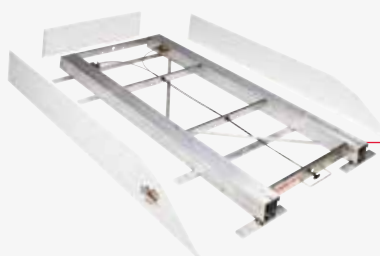

FOR FULL-SIZE VAN & MINIVAN REAR DOOR

Model 3200



ITEMIZER® Drawer Units

These storage solutions conveniently increase your storage space by placing small equipment at your fingertips without the need to crawl inside the van. Drawer dividers provide an extensive array of organizing options.

- Lightweight Aluminum Drawers carry up to 75 lbs. each
- Units Can be stacked as needed for additional storage
- Roller mounted drawers glide open to full extension
- Adjustable drawer dividers offer greater flexibility
- Anti-Skid Strips provide traction for wet and muddy boots

| MODEL | DRAWERS | HEIGHT | WIDTH | DEPTH | WEIGHT |
|-------|-----------|--------|-------|-------|----------|
| 314-3 | 1 | 6¾" | 12¼" | 49" | 26 lbs. |
| 316-3 | 2 Lateral | 6¾" | 24" | 49" | 55 lbs. |
| 317-3 | 3 Lateral | 6¾" | 36" | 49" | 85 lbs. |
| 318-3 | 4 Lateral | 6¾" | 48" | 49" | 110 lbs. |
| 326-3 | 2 Stacked | 12¼" | 12¼" | 49" | 48 lbs. |
| 327-3 | 3 Stacked | 17¾" | 12¼" | 49" | 71 lbs. |
| 328-3 | 4 Stacked | 23½" | 12¼" | 49" | 92 lbs. |

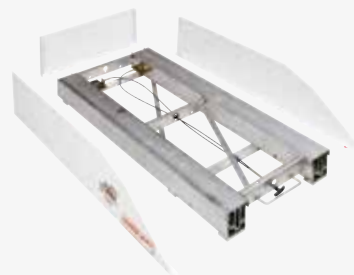

FOR FULL-SIZE VAN SIDE DOOR

Model 3100

FOR LONG WHEEL BASE FULL-SIZE VAN REAR DOOR

Model 3400

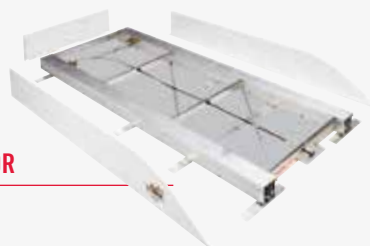

BED RAT® Sliding Platforms

| MODEL | HEIGHT | WIDTH | DEPTH | WEIGHT |
|-------|--------|----------|-------|----------|
| 3100 | 4¾" | 22"-44¾" | 54" | 97 lbs. |
| 3200 | 4¾" | 44¾" | 68" | 123 lbs. |
| 3400 | 4¾" | 44¾" | 90" | 155 lbs. |

EZGlide2™ DROP-DOWN LADDER RACK



EASIEST TO OPERATE
50% less effort to operate than competitor drop-down ladder racks, reducing strain on the operator

LIGHTEST WEIGHT
Drop-down ladder rack available

- Maximize fuel economy
- Maximize carrying capacity

MOST VERSATILE

- Up to 40' extension ladders
- 3' - 10' stepladders
- Conduit carriers

STEP 1 CHOOSE A MOUNTING KIT

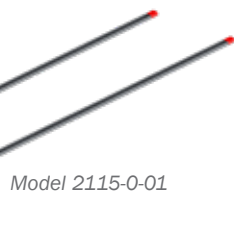

Model 2115-0-01

Mounting Channel Kits

All Mounting Channel Kits attach to factory mounting points. No drilling required. All hardware included.

| MODEL | DETAILS | WEIGHT |
|-----------|--|---------|
| 2115-0-01 | Mounting Channel Kit - ProMaster® | 15 lbs. |
| 2085-0-01 | Mounting Channel Kit - ProMaster City™ | 15 lbs. |

STEP 2 SELECT A DROP-DOWN LADDER RACK ASSEMBLY (Single-Side Only with Crossmembers)

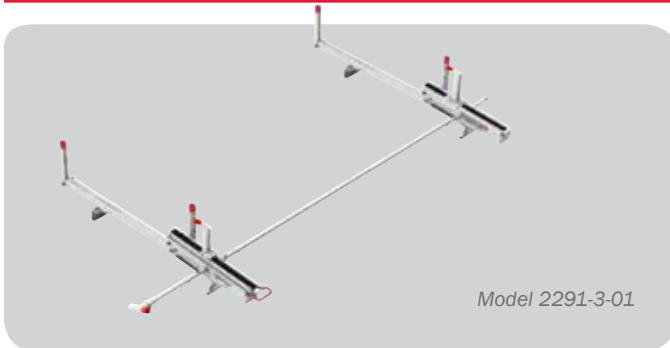

Model 2291-3-01

Drop-Down Ladder Rack Assemblies

Drop-down can mount on driver or passenger side. Rack fits 16' to 40' Extension, 5' to 10' Step and 3' to 8' Podium, evenly distributed on ladder rack. Carry ladders appropriate to the size of the vehicle.

| MODEL | DETAILS | WEIGHT |
|-----------|---|---------|
| 2291-3-01 | Extended Drop-Down - Mid-Roof or High-Roof (Includes two 70" Cross Members which can be set at 96" or 77" center to center) | 77 lbs. |
| 2261-3-01 | Fixed Drop-Down - Compact (Includes two 60" Cross Members which can be set at 77" center to center) | 83 lbs. |

Always properly secure ladders to the ladder rack while driving. Transporting ladders longer than the vehicle is not recommended.

KITS AND ACCESSORIES

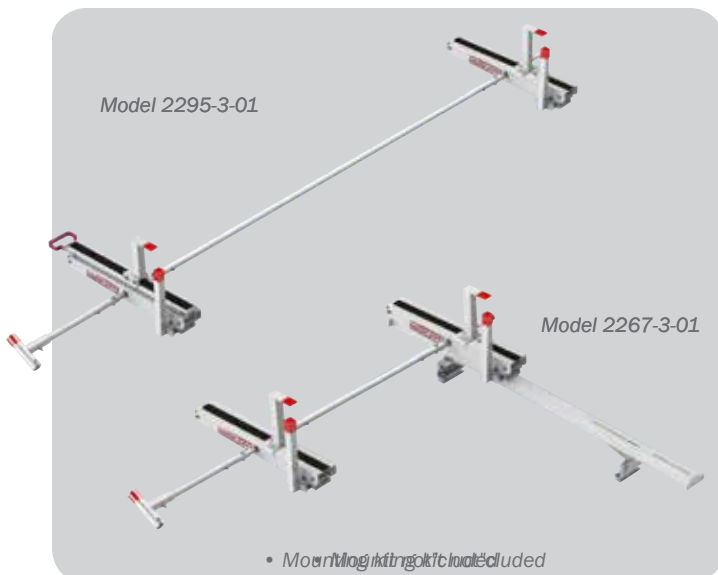

Model 2295-3-01

Model 2267-3-01

• Mounting kit not included

Dual Drop-Down Ladder Rack Accessories

| MODEL | DETAILS | WEIGHT |
|------------------------|--|---------|
| 2295-3-01 | Extended Drop-Down Long Ladder Kit - Mid-Roof/ High-Roof (Cross Members not included) Installs to 2291-3-01 | 48 lbs. |
| 2297-3-01 | Extended Drop-Down Short Ladder Kit - Mid-Roof/ High-Roof (Includes one 70" Cross Member which can be set at 42" center to center) Installs to 2291-3-01 | 55 lbs. |
| 2275-3-01 | Fixed Drop-Down Long Ladder Kit - Full Size (Cross Members not included) | 51 lbs. |
| 2277-3-01 | Fixed Drop-Down Short Ladder Kit - Full Size (Includes one 70" Cross Member which can be set at 42" center to center) Installs to 2271-3-01 | 57 lbs. |
| 2265-3-01 | Fixed Drop-Down Long Ladder Kit - Compact (Cross Members not included) | 58 lbs. |
| 2267-3-01 | Fixed Drop-Down Short Ladder Kit - Compact (Includes one 60" Cross Member which can be set at 42" center to center) Installs to 2261-3-01 | 61 lbs. |
| NEW! 2254D-3-01 | Quick Clamp Add-on Kit - Driver Side | 6 lbs. |
| NEW! 2254P-3-01 | Quick Clamp Add-on Kit - Passenger Side | 6 lbs. |
| 2060-3-01 | Accessory Cross Member - Compact (60" wide) | 6 lbs. |
| 2070-3-01 | Accessory Cross Member - Full Size (70" wide) | 6 lbs. |

VAN LADDER RACKS

WEATHER GUARD® Roof Racks are designed to mount through holes built into the new RAM ProMaster® & ProMaster City™. Roof rack mounting kit includes stands and hardware to improve rooftop mounting.

STEP 1 CHOOSE A MOUNTING KIT

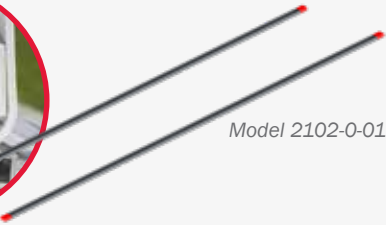

Model 2102-0-01

Mounting Channel Kits

All Mounting Channel Kits attach to factory mounting points. No drilling required. All hardware included.

| MODEL | DETAILS | WEIGHT |
|-----------|--|---------|
| 2115-0-01 | Mounting Channel Kit - ProMaster® | 15 lbs. |
| 2085-0-01 | Mounting Channel Kit - ProMaster City™ | 15 lbs. |

STEP 2 SELECT VAN RACK AND ACCESSORY CROSS MEMBERS

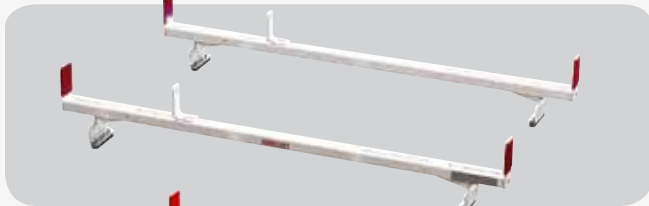

Model 224-3-03

ADJUSTABLE SWAY BRACES
for easy ladder change out



Powder Coated Aluminum Rack for ProMaster

| MODEL | DETAILS | WEIGHT |
|-----------|--|---------|
| 209-3-03 | 70" All Purpose Rack | 35 lbs. |
| 2097-3-03 | 70" All Purpose Accessory Cross Member | 19 lbs. |

Aluminum All Purpose Racks for ProMaster® City

| MODEL | DETAILS | WEIGHT |
|----------|--|---------|
| 218-3-03 | 60" All Purpose Rack | 31 lbs. |
| 222-3-03 | 60" All Purpose Accessory Cross Member | 17 lbs. |

! Quick Clamp Racks for ProMaster City

| MODEL | DETAILS | WEIGHT |
|----------|--|---------|
| 223-3-03 | 60" Single Quick Clamp Rack (curb-side only) | 44 lbs. |
| 224-3-03 | 60" Dual Quick Clamp Rack | 54 lbs. |
| 225-3-03 | 60" Quick Clamp Accessory Cross Member | 16 lbs. |

Sliding Ladder Racks

Our Sliding Ladder Rack provides quick and easy ladder storage inside your van. Rugged and durable, this rack fits up to 8-foot step, extension ladders when mounted to the roof.

| MODEL | DETAILS | WEIGHT |
|-------|---------------------|---------|
| 250 | Sliding Ladder Rack | 27 lbs. |

CONDUIT CARRIERS



Model 239

Model 237

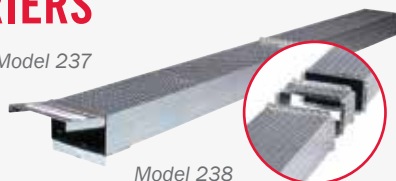

Model 238

Aluminum Conduit Carrier

Keep your conduit safe, secure, and clean with our lightweight and durable Conduit Carrier.

| MODEL | DETAILS | LENGTH | WIDTH | HEIGHT | WEIGHT |
|-------|-------------------------|--------|-------|--------|---------|
| 237 | Conduit Carrier | 121½" | 11" | 6" | 40 lbs. |
| 238 | Extension | 6" | 11" | 6" | 4 lbs. |
| 239 | PVC Conduit Carrier Kit | | | | 4 lbs. |

PVC not included. Separately purchase a section of standard 6" PVC (9ASTM D2665) plastic drain pipe. Coordinate the length of the PVC with the length of conduit you'll be carrying.



RAM PROMASTER®

The dimensions show in this guide refer to model year 2019 and earlier RAM Promaster vans. Always measure your van carefully to make sure that the equipment you choose will fit properly. Verify the location of the gas tank, brake lines, wiring harness, etc. before installing any equipment. Shelving Mounting Kits are recommended. Do not exceed the van manufacturer's roof load rating.

- Low Roof
- High Roof
- 118" Wheel Base
- 138" Wheel Base
- 159" Wheel Base
- 159" Extended Wheel Base

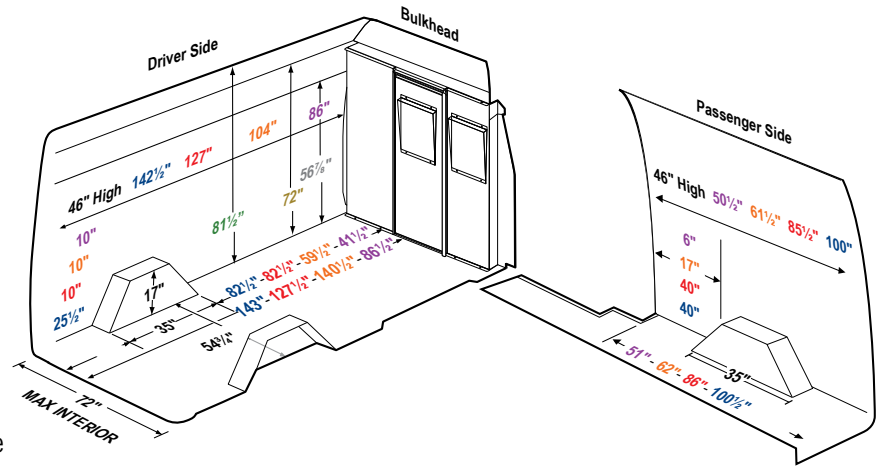

RAM PROMASTER CITY™

The dimensions show in this guide refer to model year 2019 and earlier RAM ProMaster City vans. Always measure your van carefully to make sure that the equipment you choose will fit properly. Verify the location of the gas tank, brake lines, wiring harness, etc. before installing any equipment. Shelving Mounting Kits are recommended. Do not exceed the van manufacturer's roof load rating.

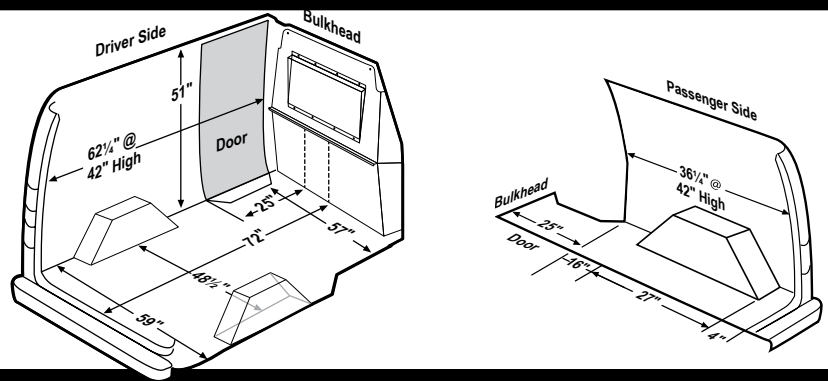

Always measure your van carefully to make sure that the equipment you choose will fit properly. Verify the location of the gas tank before installing any equipment. Shelving Mounting Kits are recommended. Do not exceed the van manufacturer's roof load rating.



LIMITED LIFETIME WARRANTY

Knaack LLC (the Manufacturer) warrants to the original purchaser, only, that WEATHER GUARD® van products (the "WEATHER GUARD Product") will be free from defects in material and workmanship from the date of purchase and continuing for the expected lifetime of the WEATHER GUARD Product. Please call our customer service department toll free at 1.800.456.7865 with any questions or comments.

DO NOT use these products for storing or transporting flammables, explosives, hazardous materials or waste, such as gasoline, solvents, gun powder, dynamite, gases or any tanks, torches or gas powered equipment. These products are intended and safe for storing and transporting small tools and other non-combustible, non-flammable materials. Any modification made to, or unintended use of, these products may create a dangerous condition causing death, serious bodily injury or property damage.

NOTICE

Any modification or unintended use of these products shall immediately void all manufacturers warranties. Manufacturer disclaims all liability for injuries to persons or property resulting from any modification to, or unintended use of these products.

Ford Transit Connect, Nissan NV, Mercedes Sprinter, and Dodge Ram CV are registered trademarks of their respective owners.

For information on the WEATHER GUARD® Van Solutions Limited Lifetime Warranty, visit www.weatherguard.com
To order more WEATHER GUARD® Van Solutions OEM brochures, please call us at **800.456.7865**



CONTACT YOUR LOCAL DISTRIBUTOR/UPFITTER